

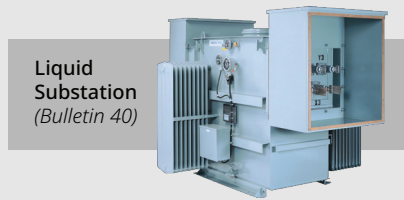

600 V CLASS, DRY TYPE, GENERAL PURPOSE DISTRIBUTION TRANSFORMERS

OTHER PRODUCTS





600 V CLASS, DRY TYPE, GENERAL PURPOSE

GENERAL INFORMATION

MGM Transformers Dry type transformers are designed, manufactured and tested in accordance with all applicable NEMA, ANSI and IEEE standards. MGMT 600 Volt class transformers are UL, CUL, and CSA listed.

STANDARD FEATURES

- DOE 2016 Compliant
- UL, CSA Listed
- Aluminum/Copper
- 60 Hz
- 1500C Temperature Rise
- ANSI/IEEE, NEMA Standard
- 220°C Insulation System

COMMON OPTIONS

- Copper Windings (CS, SS)
- Outdoor NEMA-3R Kit
- 80°C & 115°C Temperature Rise
- K-Factor; up to K20
- Wall Mount Brackets (15- 150 kVA)
- 50 Hz, 50/60 Hz, 400 Hz
- Totally Enclosed Non Ventilated
- Any Voltage Arrangement
- Stainless Steel Case (304, 316)
- Reduced Sound Level
- OSHPD Seismic Kit
- ARRA/Buy American Statues

SOUND LEVELS

MGMT 600 Volt class general purpose dry type transformers are designed to meet NEMA ST-20 sound levels.

NEMA - STANDARD SOUND LEVELS	
kVA	dB Level
0-9	40
10-50	45
51-150	50
151-300	55
301-500	60
501-700	62
701-1000	64

VOLTAGE TAPS

Taps will compensate for the high or low line voltages.

15-500 kVA transformers have 6 primary taps:
2@ 2-1/2% FCAN
4@ 2-1/2% FCBN

750 & 1,000 kVA transformers have 4 primary taps:
2@ 2-1/2% FCAN
2@ 2-1/2% FCBN

ENCLOSURES

MGMT ventilated transformers utilize a NEMA 2 rated drip proof metal enclosure with natural draft ventilation. MGMT dual rated enclosures are suitable for indoor or outdoor applications and are standard on all models except the 225, 300, 500, 750 and 1,000 kVA transformers (optional Weather-shield Kits are available for these units).

TESTING AND QUALITY ASSURANCE

As part of our quality assurance process, all 600 Volt MGMT transformers go through a rigorous ANSI/IEEE test plan to ensure optimum performance.

These tests include:

- Winding resistance test
- Turn ratio test
- Polarity and phase relation test
- No load losses and exciting current test
- Impedance and load loss test
- Applied potential test

SINGLE PHASE STOCK TRANSFORMER		
kVA	Z%	DOE 2016 Efficiency
10	4.80%	N/A
15	4.58%	97.70%
25	4.68%	98.00%
37.5	4.70%	98.20%
50	4.93%	98.30%
75	5.88%	98.50%
100	6.19%	98.60%

THREE PHASE STOCK TRANSFORMER	
kVA	DOE 2016 Efficiency
15	97.89%
30	98.23%
45	98.40%
75	98.60%
112.5	98.74%
150	98.83%
225	98.94%
300	99.02%
500	99.14%
750	99.23%
1,000	99.28%



Wiring Diagram / Voltage Taps

VOLTAGE CONFIGURATION TO WIRING DIAGRAM TABLE				
<i>Config</i>	<i>kVA</i>	<i>Total SKUs</i>	<i>Wiring</i>	<i>Wiring Diagram</i>
YS	15-500	90	480D - 208Y/120	A
YS	750-1000	20	480D - 208Y/120	K
YSSHZZ	15-1000	22	480D - 208Y/120ZZ	N
DS	15-500	18	480D - 240D/120CT	B
DS	750-1000	4	480D - 240D/120CT	L
CS	15-500	9	240D - 208Y/120	A
CS	750-1000	22	240D - 208Y/120	Q
SS	10-100	21	240x480 - 120/240	C
GB	15-500	18	208D - 208Y/120	I
GB	750-1000	4	208D - 208Y/120	C
GD	15-500	18	208D - 480Y/277	J
GD	750-1000	4	208D - 480Y/277	C
CD	15-500	18	240D - 480Y/277	J
CD	750-1000	4	240D - 480Y/277	A
AX	15-500	18	480D - 380Y/220	K
AX	750-1000	4	480D - 380Y/220	H
AXZ	15-1000	22	480D - 380Y/220	A
AD	15-500	72	480D - 480Y/277	K
AD	750-1000	16	480D - 480Y/277	F
DB	15-75	8	480Y - 208Y/120	G
DB	76-500	10	480Y - 208Y/120	M
DB	750-1000	4	480Y - 208Y/120	O
DBSHZZ	15-1000	11	480Y - 208Y/120	P
DBSHZZC	15-1000	11	480Y - 208Y/120	A
FB	15-500	90	600D - 208Y/120	K
FB	750-1000	20	600D - 208Y/120	N
FBSHZZ	15-1000	22	600D - 208Y/120	A
FD	15-500	72	600D - 480Y/277	K
FD	750-1000	16	600D - 480Y/277	F
SB	15-75	8	600Y - 208Y/120	G
SB	76-500	10	600Y - 208Y/120	M
SB	750-1000	4	600Y - 208Y/120	O
SBSHZZ	15-1000	11	600Y - 208Y/120	P
SBSHZZC	15-1000	11	600Y - 208Y/120	S
SG	10-167	18	208 - 120/240	R
SK	10-167	18	277 - 120/240	R
SUZ	10-167	18	416 - 120/240	R
SF	10-167	18	600 - 120/240	R
SVZ	10-167	14	190/200/208/220 X 380/400/416/440 - 120/240	Q

Wiring Diagram / Voltage Taps

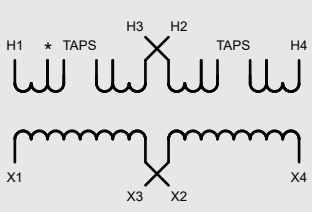
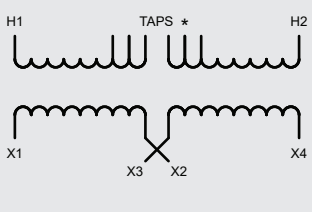
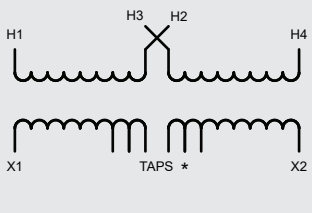
SINGLE PHASE	
Voltage Ratings	Winding Connection Diagram
190 X 380 - 120/240 200 X 400 - 120/240 208 X 416 - 120/240 220 X 440 - 120/240 240 X 480 - 120/240	<p style="text-align: center;">WIRING DIAGRAM Q</p> 
277 - 120/240 416 - 120/240 600 - 120/240	<p style="text-align: center;">WIRING DIAGRAM R</p> 
208 - 120/240	<p style="text-align: center;">WIRING DIAGRAM S</p> 

LV	LV LINKS ACROSS
240	X2 - X3
120/240	** X2 - X3
120	X1 - X3, X2 - X4

** THREE WIRE OPERATION

HV LINKS ACROSS H2- H3					
CONN.TAPS*	PRIMARY VOLTAGE				
	240	380	400	416	440
3-4, 7-8	504	399	420	437	462
3-4, 6-8	492	390	410	426	451
2-4, 6-8	480	380	400	416	440
3-5, 6-8	468	371	390	406	429
3-5, 7-9	456	361	380	395	418
2-5, 7-9	444	352	370	385	407
2-5, 6-9	432	342	360	374	396

HV LINKS ACROSS H1 - H3 and H2 - H4					
CONN.TAPS*	PRIMARY VOLTAGE				
	190	200	208	220	480
3-4, 7-8	200	210	218	231	252
2-4, 6-8	190	200	208	220	240
3-5, 7-9	181	190	198	209	228
2-5, 6-9	171	180	187	198	216

* NO. OF TAPS WILL VARY ACCORDING TO KVA RATING, CONSULT FACTORY FOR SPECIFIC TAP DETAILS

Wiring Diagram / Voltage Taps

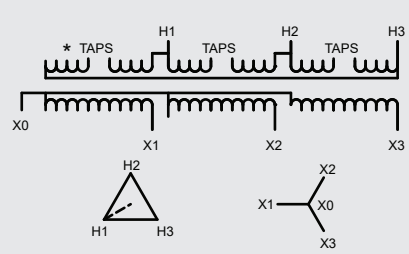
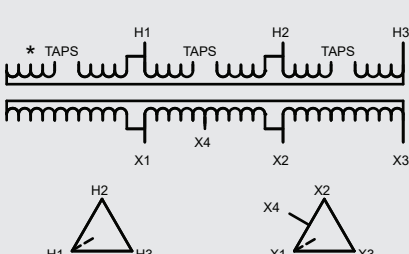
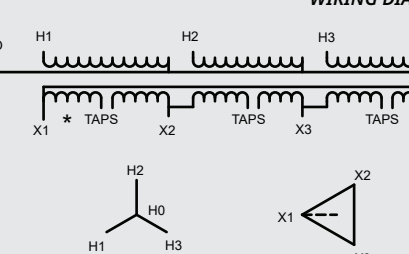
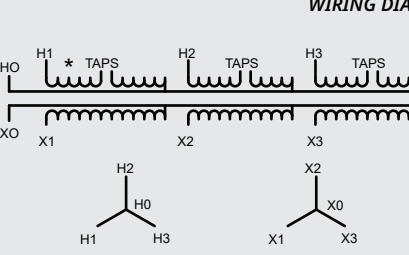
THREE PHASE, 15 KVA - 500 KVA	
Voltage Ratings	Winding Connection Diagram
240D - 208Y/120 480D - 208Y/120 480D - 380Y/220 480D - 480Y/277 480D - 240/120C 600D - 208Y/120 600D - 480Y/277	<p style="text-align: right;">WIRING DIAGRAM A</p> 
480D - 240D/120CT	<p style="text-align: right;">WIRING DIAGRAM B</p> 
208D - 208Y/120 208D - 480Y/277 240D - 480Y/277	<p style="text-align: right;">WIRING DIAGRAM C</p> 
480Y/277 - 208Y/120 600Y/346 - 208Y/120	<p style="text-align: right;">WIRING DIAGRAM D</p>  <p style="text-align: center;"><i>Up to 75 kVA- without Tertiary winding</i></p>

VOLTAGE TABLE					
CONN.TAPS*		PRIMARY VOLTAGE			
15-150kVA	225-500kVA	208	240	480	600
***H-7	4-5	218	252	504	630
H-6	4-6	213	246	492	615
H-5	3-5	208	240	480	600
H-4	3-6	203	234	468	585
H-3	2-6	198	228	456	570
H-2	3-7	192	222	444	555
H-1	2-7	187	216	432	540

*** TAP POSITION &/ NO. OF TAPS WILL VARY ACCORDING TO KVA RATING, CONSULT FACTORY FOR SPECIFIC TAP DETAILS**

- 120 volt single phase output can be obtained between X1 and X4 (5% of capacity) & X2 and X4 (5% of capacity).
- If maximum of 10% single phase output is used, three phase capacity is reduced by 15%.
- X4 to be grounded for single phase neutral connection.
- If X4 is grounded - NO other phase (X1, X2, X3) or primary phases H1, H2, H3 should be grounded.
- Voltage between X4-X3 will be 208V - often referred as high leg.

Wiring Diagram / Voltage Taps

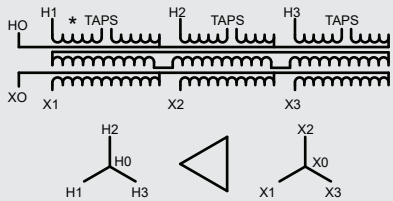
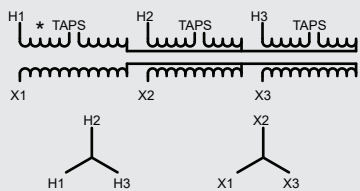
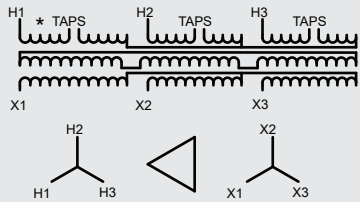
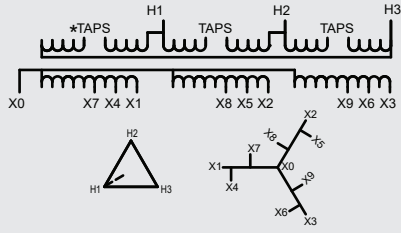
THREE PHASE, 15 kVA - 500 kVA	
<i>Voltage Ratings</i>	<i>Winding Connection Diagram</i>
480Y/277 - 208Y/120 600Y/346 - 208Y/120 (with neutral)	<p>WIRING DIAGRAM E</p>  <p><i>76 kVA and above - with Delta Tertiary winding</i></p>
480Y - 208Y 600Y - 208Y	<p>WIRING DIAGRAM F</p>  <p><i>Up to 75 kVA - without Tertiary winding</i></p>
480Y - 208Y 600Y - 208Y (no neutral)	<p>WIRING DIAGRAM G</p>  <p><i>76 kVA and above - with Delta Tertiary winding</i></p>
480D - 480Y / 380Y / 208Y	<p>WIRING DIAGRAM H</p> 

VOLTAGE TABLE					
CONN.TAPS*		PRIMARY VOLTAGE			
15-150kVA	225-500kVA	208	240	480	600
***H-7	4-5	218	252	504	630
H-6	4-6	213	246	492	615
H-5	3-5	208	240	480	600
H-4	3-6	203	234	468	585
H-3	2-6	198	228	456	570
H-2	3-7	192	222	444	555
H-1	2-7	187	216	432	540

*** TAP POSITION &/ NO. OF TAPS WILL VARY
ACCORDING TO KVA RATING, CONSULT FACTORY FOR
SPECIFIC TAP DETAILS**

Wiring Diagram / Voltage Taps

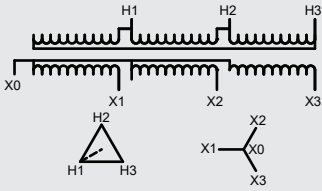
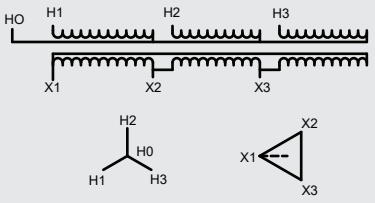
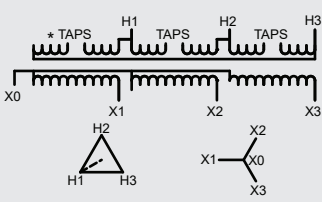
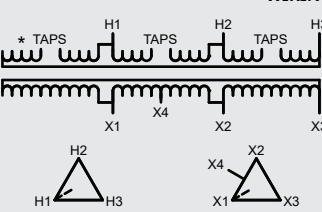
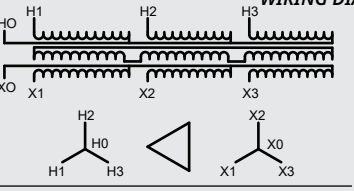
Three Phase, 750kVA - 1000kVA	
Voltage Ratings	Winding Connection Diagram
208D - 208Y/120 240D - 208Y/120 (NO TAPS)	<p>WIRING DIAGRAM I</p> 
208D - 480Y/277 240D - 480Y/120 240D - 480Y/277 (NO TAPS)	<p>WIRING DIAGRAM G</p> 
480D - 208Y/120 480D - 380Y/220 480D - 480Y/277 600D - 208Y/120 600D - 480Y/277 (TAPS: ,2A2B)	<p>WIRING DIAGRAM K</p> 
4800 - 2400/120CT (TAPS : 2A2B)	<p>WIRING DIAGRAM L</p> 
480Y/277 - 208Y/120 600Y/346 - 208Y/120 (NO TAPS)	<p>WIRING DIAGRAM M</p>  <p><i>with Tertiary winding (Enclosed Delta)</i></p>

VOLTAGE TABLE		
CONN.TAPS*	PRIMARY VOLTAGE	
	480 D	600 D
750 - 1000 kVA		
4-5	504	630
4-6	492	615
3-6	480	600
3-7	468	585
2-7	456	570

Wiring Diagram / Voltage Taps

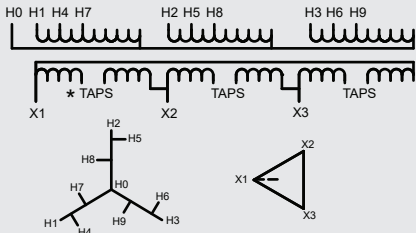
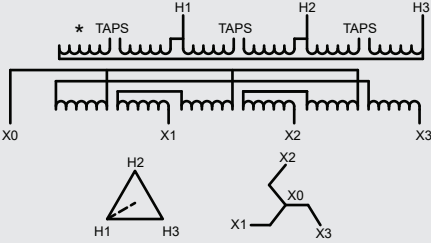
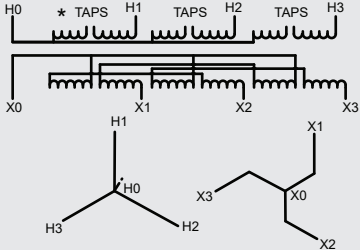
THREE PHASE, SHIELDED	
Voltage Ratings	Winding Connection Diagram
208D - 480Y/380Y/208Y 480D - 480Y/380Y/208Y 600D - 480Y/380Y/208Y	<p>WIRING DIAGRAM N</p> 
480 - 208Y/120ZZ 600 - 208Y/120ZZ (0° Shift)	<p>WIRING DIAGRAM O</p> 
480Y/277 - 208Y/120ZZ 600Y/346 - 208Y/120ZZ (30° Shift)	<p>WIRING DIAGRAM P</p> 

VOLTAGE TABLE					
CONN.TAPS*		PRIMARY VOLTAGE			
15-150kVA	225-500kVA	208	240	480	600
***H-7	4-5	218	252	504	630
H-6	4-6	213	246	492	615
H-5	3-5	208	240	480	600
H-4	3-6	203	234	468	585
H-3	2-6	198	228	456	570
H-2	3-7	192	222	444	555
H-1	2-7	187	216	432	540

General Purpose - Aluminum — 1 Phase

Aluminum | Primary: 240 x 480 | Secondary: 120/240V | 150CRise

Catalog Number	Alt #	kVA	Width (Inches)	Depth (Inches)	Height (Inches)	Weight (Lbs)	Wiring Diagram	Dimension Drawing
HS10C3B2-D16	10SS*D16	10	21	14	28	175	Q	A
HS15C3B2-D16	15SS*D16	15	21	14	28	205	Q	A
HS25C3B2-D16	25SS*D16	25	26.5	17	32	270	Q	B
HS37C3B2-D16	37SS*D16	37.5	26.5	17	32	345	Q	B
HS50C3B2-D16	50SS*D16	50	26.5	17	32	385	Q	B
HS75C3B2-D16	75SS*D16	75	28.5	20	38.5	530	Q	B+
HS100C3B2-D16	100SS*D16	100	31.5	21.75	40.5	645	Q	C

Aluminum | Primary: 190/200/208/220 x 380/400/416/440 | Secondary: 120/240v | 150CRise

Catalog Number	Alt #	kVA	Width (Inches)	Depth (Inches)	Height (Inches)	Weight (Lbs)	Wiring Diagram	Dimension Drawing
HS10VZ3B2-D16	10SVZ*D16	10	21	14	28	175	Q	A
HS15VZ3B2-D16	15SVZ*D16	15	21	14	28	205	Q	A
HS25VZ3B2-D16	25SVZ*D16	25	26.5	17	32	270	Q	B
HS37VZ3B2-D16	37SVZ*D16	37.5	26.5	17	32	345	Q	B
HS50VZ3B2-D16	50SVZ*D16	50	26.5	17	32	385	Q	B
HS75VZ3B2-D16	75SVZ*D16	75	28.5	20	38.5	530	Q	B+
HS100VZ3B2-D16	100SVZ*D16	100	36.5	21.75	40.5	675	Q	C+

Aluminum | Primary: 208 | Secondary: 120/240V | 150CRise

Catalog Number	Alt #	kVA	Width (Inches)	Depth (Inches)	Height (Inches)	Weight (Lbs)	Wiring Diagram	Dimension Drawing
HS10G3B2-D16	10SG*D16	10	21	14	28	175	S	A
HS15G3B2-D16	15SG*D16	15	21	14	28	205	S	A
HS25G3B2-D16	25SG*D16	25	26.5	17	32	270	S	B
HS37G3B2-D16	37SG*D16	37.5	26.5	17	32	345	S	B
HS50G3B2-D16	50SG*D16	50	26.5	17	32	385	S	B
HS75G3B2-D16	75SG*D16	75	28.5	20	38.5	530	S	B+
HS100G3B2-D16	100SG*D16	100	31.5	21.75	40.5	645	S	C
HS150G3B2-D16	150SG*D16	150	40.5	26.5	51.5	790	S	D
HS167G3B2-D16	167SG*D16	167	40.5	26.5	51.5	880	S	D

Aluminum | Primary: 277 | Secondary: 120/240V | 150CRise

Catalog Number	Alt #	kVA	Width (Inches)	Depth (Inches)	Height (Inches)	Weight (Lbs)	Wiring Diagram	Dimension Drawing
HS10K3B2-D16	10SK*D16	10	21	14	28	175	R	A
HS15K3B2-D16	15SK*D16	15	21	14	28	205	R	A
HS25K3B2-D16	25SK*D16	25	26.5	17	32	270	R	B
HS37K3B2-D16	37SK*D16	37.5	26.5	17	32	345	R	B
HS50K3B2-D16	50SK*D16	50	26.5	17	32	385	R	B
HS75K3B2-D16	75SK*D16	75	28.5	20	38.5	530	R	B+
HS100K3B2-D16	100SK*D16	100	31.5	21.75	40.5	645	R	C
HS150K3B2-D16	150SK*D16	150	40.5	26.5	51.5	790	R	D
HS167K3B2-D16	167SK*D16	167	40.5	26.5	51.5	880	R	D



**600 V CLASS, DRY TYPE,
GENERAL PURPOSE**

General Purpose - Aluminum — 1 Phase

Aluminum | Primary: 416 | Secondary: 120/240V | 150CRise

<i>Catalog Number</i>	<i>Alt #</i>	<i>kVA</i>	<i>Width (Inches)</i>	<i>Depth (Inches)</i>	<i>Height (Inches)</i>	<i>Weight (Lbs)</i>	<i>Wiring Diagram</i>	<i>Dimension Drawing</i>
HS10UZ3B2-D16	10SUZ*D16	10	21	14	28	175	R	A
HS15UZ3B2-D16	15SUZ*D16	15	21	14	28	205	R	A
HS25UZ3B2-D16	25SUZ*D16	25	26.5	17	32	270	R	B
HS37UZ3B2-D16	37SUZ*D16	37.5	26.5	17	32	345	R	B
HS50UZ3B2-D16	50SUZ*D16	50	26.5	17	32	385	R	B
HS75UZ3B2-D16	75SUZ*D16	75	28.5	20	38.5	530	R	B+
HS100UZ3B2-D16	100SUZ*D16	100	31.5	21.75	40.5	645	R	C
HS150UZ3B2-D16	150SUZ*D16	150	40.5	26.5	51.5	790	R	D
HS167UZ3B2-D16	167SUZ*D16	167	40.5	26.5	51.5	880	R	D

Aluminum | Primary: 600 | Secondary: 120/240V | 150CRise

<i>Catalog Number</i>	<i>Alt #</i>	<i>kVA</i>	<i>Width (Inches)</i>	<i>Depth (Inches)</i>	<i>Height (Inches)</i>	<i>Weight (Lbs)</i>	<i>Wiring Diagram</i>	<i>Dimension Drawing</i>
HS10F3B2-D16	10SF*D16	10	21	14	28	175	R	A
HS15F3B2-D16	15SF*D16	15	21	14	28	205	R	A
HS25F3B2-D16	25SF*D16	25	26.5	17	32	270	R	B
HS37F3B2-D16	37SF*D16	37.5	26.5	17	32	345	R	B
HS50F3B2-D16	50SF*D16	50	26.5	17	32	385	R	B
HS75F3B2-D16	75SF*D16	75	28.5	20	38.5	530	R	B+
HS100F3B2-D16	100SF*D16	100	31.5	21.75	40.5	645	R	C
HS150F3B2-D16	150SF*D16	150	40.5	26.5	51.5	790	R	D
HS167F3B2-D16	167SF*D16	167	40.5	26.5	51.5	880	R	D

General Purpose - Aluminum — 3 Phase

Aluminum | Primary: 480D | Secondary: 240D/120CT | 150CRise

Catalog Number	Alt #	kVA	Width (Inches)	Depth (Inches)	Height (Inches)	Weight (Lbs)	Wiring Diagram	Dimension Drawing
HT15A3K2-D16	15DS*D16	15	21	14	28	240	B	A
HT30A3K2-D16	30DS*D16	30	26.5	17	32	355	B	B
HT45A3K2-D16	45DS*D16	45	26.5	17	32	425	B	B
HT75A3K2-D16	75DS*D16	75	28.5	20	38.5	590	B	B+
HT112A3K2-D16	112DS*D16	112	31.5	21.75	40.5	790	B	C
HT150A3K2-D16	150DS*D16	150	36.5	21.75	40.5	1015	B	C+
HT225A3K2-D16	225DS*D16	225	40.5	26.5	51.5	1570	B	D
HT300A3K2-D16	300DS*D16	300	40.5	26.5	51.5	1865	B	D
HT500A3K2-D16	500DS*D16	500	50.5	32	66	3215	B	E
HT750A3K2-D16	750DS*D16	750	64	44	80	3750	L	F
HT1000A3K2-D16	1000DS*D16	1000	64	44	80	5000	L	F

Aluminum | Primary: 240D | Secondary: 208Y/120V | 150CRise

Catalog Number	Alt #	kVA	Width (Inches)	Depth (Inches)	Height (Inches)	Weight (Lbs)	Wiring Diagram	Dimension Drawing
HT15C3B2-D16	15CS*D16	15	21	14	28	235	A	A
HT30C3B2-D16	30CS*D16	30	26.5	17	32	355	A	B
HT45C3B2-D16	45CS*D16	45	26.5	17	32	425	A	B
HT75C3B2-D16	75CS*D16	75	28.5	20	38.5	595	A	B+
HT112C3B2-D16	112CS*D16	112	31.5	21.75	40.5	795	A	C
HT150C3B2-D16	150CS*D16	150	36.5	21.75	40.5	1010	A	C+
HT225C3B2-D16	225CS*D16	225	40.5	26.5	51.5	1580	A	D
HT300C3B2-D16	300CS*D16	300	40.5	26.5	51.5	1875	A	D
HT500C3B2-D16	500CS*D16	500	50.5	32	66	3295	A	E
HT750C3B2-D16	750CS*D16	750	64	44	80	3750	I	F
HT1000C3B2-D16	1000CS*D16	1000	64	44	80	5000	I	F

Aluminum | Primary: 208D | Secondary: 208Y/120 | 150CRise | K1

Catalog Number	Alt #	kVA	Width (Inches)	Depth (Inches)	Height (Inches)	Weight (Lbs)	Wiring Diagram	Dimension Drawing
HT15G3B2-D16	15GB*D16	15	28	21	14	245	C	A
HT30G3B2-D16	30GB*D16	30	32	26.5	17	335	C	B
HT45G3B2-D16	45GB*D16	45	32	26.5	17	400	C	B
HT75G3B2-D16	75GB*D16	75	38.5	28.5	20	545	C	B+
HT112G3B2-D16	112GB*D16	112	40.5	31.5	27.75	755	C	C
HT150G3B2-D16	150GB*D16	150	40.5	36.5	21.75	900	C	C+
HT225G3B2-D16	225GB*D16	225	51.5	40.5	26.5	1585	C	D
HT300G3B2-D16	300GB*D16	300	51.5	40.5	26.5	2000	C	D
HT500G3B2-D16	500GB*D16	500	66	50.5	32	2800	C	E
HT750G3B2-D16	750GB*D16	750	80.25	64	44.25	3800	I	F
HT1000G3B2-D16	1000GB*D16	1000	80.25	64	44.25	5000	I	F



**600 V CLASS, DRY TYPE,
GENERAL PURPOSE**

General Purpose - Aluminum — 3 Phase

Aluminum | Primary: 208D | Secondary: 480Y/277 | 150CRise | K1

Catalog Number	Alt #	kVA	Width (Inches)	Depth (Inches)	Height (Inches)	Weight (Lbs)	Wiring Diagram	Dimension Drawing
HT15G3D2-D16	15GD*D16	15	28	21	14	245	C	A
HT30G3D2-D16	30GD*D16	30	32	26.5	17	335	C	B
HT45G3D2-D16	45GD*D16	45	32	26.5	17	400	C	B
HT75G3D2-D16	75GD*D16	75	38.5	28.5	20	545	C	B+
HT112G3D2-D16	112GD*D16	112	40.5	31.5	27.75	755	C	C
HT150G3D2-D16	150GD*D16	150	40.5	36.5	21.75	900	C	C+
HT225G3D2-D16	225GD*D16	225	51.5	40.5	26.5	1585	C	D
HT300G3D2-D16	300GD*D16	300	51.5	40.5	26.5	2000	C	D
HT500G3D2-D16	SOOGD*D16	500	66	50.5	32	2800	C	E
HT750G3D2-D16	750GD*D16	750	80.25	64	44.25	3800	J	F
HT1000G3D2-D16	1000GD*D16	1000	80.25	64	44.25	5000	J	F

Aluminum | Primary: 240D | Secondary: 480Y/277 | 150CRise | K1

Catalog Number	Alt #	kVA	Width (Inches)	Depth (Inches)	Height (Inches)	Weight (Lbs)	Wiring Diagram	Dimension Drawing
HT15C3D2-D16	15CD*D16	15	28	21	14	245	C	A
HT30C3D2-D16	30CD*D16	30	32	26.5	17	335	C	B
HT45C3D2-D16	45CD*D16	45	32	26.5	17	400	C	B
HT75C3D2-D16	75CD*D16	75	38.5	28.5	20	545	C	B+
HT112C3D2-D16	112CD*D16	112	40.5	31.5	27.75	755	C	C
HT150C3D2-D16	150CD*D16	150	40.5	36.5	21.75	900	C	C+
HT225C3D2-D16	225CD*D16	225	51.5	40.5	26.5	1585	C	D
HT300C3D2-D16	300CD*D16	300	51.5	40.5	26.5	2000	C	D
HT500C3D2-D16	500CD*D16	500	66	50.5	32	2800	C	E
HT750C3D2-D16	750CD*D16	750	80.25	64	44.25	3800	J	F
HT1000C3D2-D16	1000CD*D16	1000	80.25	64	44.25	5000	J	F

Aluminum | Primary: 480D | Secondary: 380Y/220, 400Y/231, 416Y/240, 430Y/248 | 150CRise | K1

Catalog Number	Alt #	kVA	Width (Inches)	Depth (Inches)	Height (Inches)	Weight (Lbs)	Wiring Diagram	Dimension Drawing
HT15A3XZ2-D16	15AXZ*D16	15	28	21	14	245	H	A
HT30A3XZ2-D16	30AXZ*D16	30	32	26.5	17	335	H	B
HT45A3XZ2-D16	45AXZ*D16	45	32	26.5	17	400	H	B
HT75A3XZ2-D16	75AXZ*D16	75	38.5	28.5	20	545	H	B+
HT112A3XZ2-D16	112AXZ*D16	112	40.5	31.5	27.75	755	H	C
HT150A3XZ2-D16	150AXZ*D16	150	40.5	36.5	21.75	900	H	C+
HT225A3XZ2-D16	225AXZ*D16	225	51.5	40.5	26.5	1585	H	D
HT300A3XZ2-D16	300AXZ*D16	300	51.5	40.5	26.5	2000	H	D
HT500A3XZ2-D16	SOOAXZ*D16	500	66	50.5	32	2800	H	E
HT750A3XZ2-D16	750AXZ*D16	750	80.25	64	44.25	3800	H	F
HT1000A3XZ2-D16	1000AXZ*D16	1000	80.25	64	44.25	5000	H	F

General Purpose - Aluminum — 3 Phase

Aluminum | Primary: 480D | Secondary: 480Y/277 | 150CRise | K1

Catalog Number	Alt #	kVA	Width (Inches)	Depth (Inches)	Height (Inches)	Weight (Lbs)	Wiring Diagram	Dimension Drawing
HT15A3D2-D16	15AD*D16	15	28	21	14	245	A	A
HT30A3D2-D16	30AD*D16	30	32	26.5	17	335	A	B
HT45A3D2-D16	45AD*D16	45	32	26.5	17	400	A	B
HT75A3D2-D16	75AD*D16	75	38.5	28.5	20	545	A	B+
HT112A3D2-D16	112AD*D16	112	40.5	31.5	27.75	755	A	C
HT150A3D2-D16	150AD*D16	150	40.5	36.5	21.75	900	A	C+
HT225A3D2-D16	225AD*D16	225	51.5	40.5	26.5	1585	A	D
HT300A3D2-D16	300AD*D16	300	51.5	40.5	26.5	2000	A	D
HT500A3D2-D16	500AD*D16	500	66	50.5	32	2800	A	E
HT750A3D2-D16	750AD*D16	750	80.25	64	44.25	3800	K	F
HT1000A3D2-D16	1000AD*D16	1000	80.25	64	44.25	5000	K	F

Aluminum | Primary: 600D | Secondary: 208Y/120 | 150CRise | K1

Catalog Number	Alt #	kVA	Width (Inches)	Depth (Inches)	Height (Inches)	Weight (Lbs)	Wiring Diagram	Dimension Drawing
HT15F3B2-D16	15FB*D16	15	28	21	14	245	A	A
HT30F3B2-D16	30FB*D16	30	32	26.5	17	335	A	B
HT45F3B2-D16	45FB*D16	45	32	26.5	17	400	A	B
HT75F3B2-D16	75FB*D16	75	38.5	28.5	20	545	A	B+
HT112F3B2-D16	112FB*D16	112	40.5	31.5	27.75	755	A	C
HT150F3B2-D16	150FB*D16	150	40.5	36.5	21.75	900	A	C+
HT225F3B2-D16	225FB*D16	225	51.5	40.5	26.5	1585	A	D
HT300F3B2-D16	300FB*D16	300	51.5	40.5	26.5	2000	A	D
HT500F3B2-D16	500FB*D16	500	66	50.5	32	2800	A	E
HT750F3B2-D16	750FB*D16	750	80.25	64	44.25	3800	K	F
HT1000F3B2-D16	1000FB*D16	1000	80.25	64	44.25	5000	K	F

Aluminum | Primary: 600D | Secondary: 480Y/277 | 150CRise | K1

Catalog Number	Alt #	kVA	Width (Inches)	Depth (Inches)	Height (Inches)	Weight (Lbs)	Wiring Diagram	Dimension Drawing
HT15F3D2-D16	15FD*D16	15	28	21	14	245	A	A
HT30F3D2-D16	30FD*D16	30	32	26.5	17	335	A	B
HT45F3D2-D16	45FD*D16	45	32	26.5	17	400	A	B
HT75F3D2-D16	75FD*D16	75	38.5	28.5	20	545	A	B+
HT112F3D2-D16	112FD*D16	112	40.5	31.5	27.75	755	A	C
HT150F3D2-D16	150FD*D16	150	40.5	36.5	21.75	900	A	C+
HT225F3D2-D16	225FD*D16	225	51.5	40.5	26.5	1585	A	D
HT300F3D2-D16	300FD*D16	300	51.5	40.5	26.5	2000	A	D
HT500F3D2-D16	500FD*D16	500	66	50.5	32	2800	A	E
HT750F3D2-D16	750FD*D16	750	80.25	64	44.25	3800	K	F
HT1000F3D2-D16	1000FD*D16	1000	80.25	64	44.25	5000	K	F

General Purpose - Copper — 1 Phase

Copper | Primary: 240 x 480 | Secondary: 120/240V | 150CRise

Catalog Number	Alt #	kVA	Width (Inches)	Depth (Inches)	Height (Inches)	Weight (Lbs)	Wiring Diagram	Dimension Drawing
HS10C3B2-D16	10SSC*D16	10	21	14	28	175	Q	A
HS15C3B2-D16	15SSC*D16	15	21	14	28	205	Q	A
HS25C3B2-D16	25SSC*D16	25	26.5	17	32	270	Q	B
HS37C3B2-D16	37SSC*D16	37.5	26.5	17	32	345	Q	B
HS50C3B2-D16	50SSC*D16	50	26.5	17	32	385	Q	B
HS75C3B2-D16	75SSC*D16	75	28.5	20	38.5	530	Q	B+
HS100C3B2-D16	100SSC*D16	100	31.5	21.75	40.5	645	Q	C

Copper | Primary: 190/200/208/220 x 380/400/416/440 | Secondary: 120/240V | 150CRise

Catalog Number	Alt #	kVA	Width (Inches)	Depth (Inches)	Height (Inches)	Weight (Lbs)	Wiring Diagram	Dimension Drawing
HS10VZ3B2-D16	10SVzc*D16	10	21	14	28	175	Q	A
HS15VZ3B2-D16	15SVZC*D16	15	21	14	28	205	Q	A
HS25VZ3B2-D16	25svzc*D16	25	26.5	17	32	270	Q	B
HS37VZ3B2-D16	37SVZC*D16	37.5	26.5	17	32	345	Q	B
HS50VZ3B2-D16	50SVZC*D16	50	26.5	17	32	385	Q	B
HS75VZ3B2-D16	75SVZC*D16	75	28.5	20	38.5	530	Q	B+
HS100VZ3B2-D16	100SVZC*D16	100	31.5	21.75	40.5	645	Q	C

Copper | Primary: 208 | Secondary: 120/240V | 150CRise

Catalog Number	Alt #	kVA	Width (Inches)	Depth (Inches)	Height (Inches)	Weight (Lbs)	Wiring Diagram	Dimension Drawing
HS10tG3B2-D16	10SGC*D16	10	21	14	28	175	S	A
HS15G3B2-D16	15SGC*D16	15	21	14	28	205	S	A
HS25G3B2-D16	25SGC*D16	25	26.5	17	32	270	S	B
HS37G3B2-D16	37SGC*D16	37.5	26.5	17	32	345	S	B
HS50G3B2-D16	50SGC*D16	50	26.5	17	32	385	S	B
HS75G3B2-D16	75SGC*D16	75	28.5	20	38.5	530	S	B+
HS100G3B2-D16	100SGC*D16	100	31.5	21.75	40.5	645	S	C
HS150G3B2-D16	150SGC*D16	150	40.5	26.5	51.5	790	S	D
HS167G3B2-D16	167SGC*D16	167	40.5	26.5	51.5	880	S	D

Copper | Primary: 277 | Secondary: 120/240V | 150CRise

Catalog Number	Alt #	kVA	Width (Inches)	Depth (Inches)	Height (Inches)	Weight (Lbs)	Wiring Diagram	Dimension Drawing
HS10K3B2-D16	10SKC*D16	10	21	14	28	175	R	A
HS15K3B2-D16	15SKC*D16	15	21	14	28	205	R	A
HS25K3B2-D16	25SKC*D16	25	26.5	17	32	270	R	B
HS37K3B2-D16	37SKC*D16	37.5	26.5	17	32	345	R	B
HS50K3B2-D16	50SKC*D16	50	26.5	17	32	385	R	B
HS75K3B2-D16	75SKC*D16	75	28.5	20	38.5	530	R	B+
HS100K3B2-D16	100SKC*D16	100	31.5	21.75	40.5	645	R	C
HS150K3B2-D16	150SKC*D16	150	40.5	26.5	51.5	790	R	D
HS167K3B2-D16	167SKC*D16	167	40.5	26.5	51.5	880	R	D

General Purpose - Copper — 1 Phase

Copper | Primary: 416 | Secondary: 120/240V | 150CRise

Catalog Number	Alt #	kVA	Width (Inches)	Depth (Inches)	Height (Inches)	Weight (Lbs)	Wiring Diagram	Dimension Drawing
HS10UZ3B2016	10SUZC*D16	10	21	14	28	175	R	A
HS15UZ3B2016	15SUZC*D16	15	21	14	28	205	R	A
HS25UZ3B2-D16	25SUZC*D16	25	26.5	17	32	270	R	B
HS37UZ3B2016	37SUzc*D16	37.5	26.5	17	32	345	R	B
HS50UZ3B2016	50SUZC*D16	50	26.5	17	32	385	R	B
HS75UZ3B2016	75SUZC*D16	75	28.5	20	38.5	530	R	B+
HS100UZ3B2-D16	100SUZC*D16	100	31.5	21.75	40.5	645	R	C
HS150UZ3B2-D16	150SUZC*D16	150	40.5	26.5	51.5	790	R	D
HS167UZ3B2-D16	167SUZC*D16	167	40.5	26.5	51.5	880	R	D

Copper | Primary: 600 | Secondary: 120/240V | 150CRise

Catalog Number	Alt #	kVA	Width (Inches)	Depth (Inches)	Height (Inches)	Weight (Lbs)	Wiring Diagram	Dimension Drawing
HS10F3B2-D16	10SFC*D16	10	21	14	28	175	R	A
HS15F3B2-D16	15SFC*D16	15	21	14	28	205	R	A
HS25F3B2-D16	25SFC*D16	25	26.5	17	32	270	R	B
HS37F3B2-D16	37SFC*D16	37.5	26.5	17	32	345	R	B
HS50F3B2-D16	50SFC*D16	50	26.5	17	32	385	R	B
HS75F3B2-D16	75SFC*D16	75	28.5	20	38.5	530	R	B+
HS100F3B2-D16	100SFC*D16	100	31.5	21.75	40.5	645	R	C
HS150F3B2-D16	150SFC*D16	150	40.5	26.5	51.5	790	R	D
HS167F3B2-D16	167SFC*D16	167	40.5	26.5	51.5	880	R	D

General Purpose - Copper — 3 Phase

Copper | Primary: 480D | Secondary: 208Y/120V | 150CRise

Catalog Number	Alt #	kVA	Width (Inches)	Depth (Inches)	Height (Inches)	Weight (Lbs)	Wiring Diagram	Dimension Drawing
HT15A3B1-D16	15YSC*D16	15	21	14	28	250	A	A
HT30A3B1-D16	30YSC*D16	30	26.5	17	32	370	A	B
HT45A3B1-D16	45YSC*D16	45	26.5	17	32	455	A	B
HT75A3B1-D16	75YSC*D16	75	28.5	20	38.5	645	A	B+
HT112A3B1-D16	112YSC*D16	112.5	31.5	21.75	40.5	840	A	C
HT150A3B1-D16	150YSC*D16	150	36.5	21.75	40.5	1045	A	C+
HT225A3B1-D16	225YSC*D16	225	40.5	26.5	51.5	1720	A	D
HT300A3B1-D16	300YSC*D16	300	40.5	26.5	51.5	1940	A	D
HT500A3B1-D16	500YSC*D16	500	50.5	32	66	3425	A	E
HT750A3B1-D16	750YSC*D16	750	80.25	64	44.25	3860	K	F
HT1000A3B1-D16	1000YSC*D16	1000	80.25	64	44.25	5100	K	F

General Purpose - Copper — 3 Phase

Copper | Primary: 480D | Secondary: 240D/120CT | 150CRise

Catalog Number	Alt #	kVA	Width (Inches)	Depth (Inches)	Height (Inches)	Weight (Lbs)	Wiring Diagram	Dimension Drawing
HT15A3K1-D16	15Dsc*D16	15	21	14	28	250	B	A
HT30A3K1-D16	30DSC*D16	30	26.5	17	32	370	B	B
HT45A3K1-D16	45DSC*D16	45	26.5	17	32	455	B	B
HT75A3K1-D16	75DSC*D16	75	28.5	20	38.5	645	B	B+
HT112A3K1-D16	112DSC*D16	112.5	31.5	21.75	40.5	840	B	C
HT150A3K1-D16	150DSC*D16	150	36.5	21.75	40.5	1045	B	C+
HT225A3K1-D16	225DSC*	225	40.5	26.5	51.5	1720	B	D
HT300A3K1-D16	300DSC*D16	300	40.5	26.5	51.5	1940	B	D
HT500A3K1-D16	500DSC*D16	500	50.5	32	66	3425	B	E
HT750A3K1-D16	750DSC*D16	750	80.25	64	44.25	3860	L	F
HT1000A3K1-D16	1000DSC*D16	1000	80.25	64	44.25	5100	L	F

Copper | Primary: 208D | Secondary: 208Y/120 | 150CRise | K1

Catalog Number	Alt #	kVA	Width (Inches)	Depth (Inches)	Height (Inches)	Weight (Lbs)	Wiring Diagram	Dimension Drawing
HT15G3B1-D16	15GBC*D16	15	28	21	14	245	C	A
HT30G3B1-D16	30GBC*D16	30	32	26.5	17	340	C	B
HT45G3B1-D16	45GBC*D16	45	32	26.5	17	405	C	B
HT75G3B1-D16	75GBC*D16	75	38.5	28.5	20	555	C	B+
HT112G3B1-D16	112GBC*D16	112	40.5	31.5	27.75	765	C	C
HT150G3B1-1)16	150GBC*D16	150	40.5	36.5	21.75	910	C	C+
HT225G3B1-D16	225GBC*D16	225	51.5	40.5	26.5	1600	C	D
HT300G3B1-D16	300GBC*D16	300	51.5	40.5	26.5	2030	C	D
HT500G3B1-D16	500GBC*D16	500	66	50.5	32	2850	C	E
HT750G3B1-D16	750GBC*D16	750	80.25	64	44.25	3860	I	F
HT1000G3B1-D16	1000GBC*D16	1000	80.25	64	44.25	5100	I	F

Copper | Primary: 208D | Secondary: 480Y/277 | 150CRise | K1

Catalog Number	Alt #	kVA	Width (Inches)	Depth (Inches)	Height (Inches)	Weight (Lbs)	Wiring Diagram	Dimension Drawing
HT15G3D1-D16	15GDC*D16	15	28	21	14	245	C	A
HT30G3D1-D16	30GDC*D16	30	32	26.5	17	340	C	B
HT45G3D1-D16	45GDC*D16	45	32	26.5	17	405	C	B
HT75G3D1-D16	75GDC*D16	75	38.5	28.5	20	555	C	B+
HT112G3D1-D16	112GDC*D16	112	40.5	31.5	27.75	765	C	C
HT150G3D1-D16	150GDC*D16	150	40.5	36.5	21.75	910	C	C+
HT225G3D1-D16	225GDC*D16	225	51.5	40.5	26.5	1600	C	D
HT300G3D1-D16	300GDC*D16	300	51.5	40.5	26.5	2030	C	D
HT500G3D1-C)16	500GDC*D16	500	66	50.5	32	2850	C	E
HT750G3D1-D16	750GDC*D16	750	80.25	64	44.25	3860	J	F
HT1000tG3D1-D16	1000GDC*D16	1000	80.25	64	44.25	5100	J	F

General Purpose - Copper — 3 Phase

Copper | Primary: 240D | Secondary: 480Y/277 | 150CRise | K1

Catalog Number	Alt #	kVA	Width (Inches)	Depth (Inches)	Height (Inches)	Weight (Lbs)	Wiring Diagram	Dimension Drawing
HT15C3D1-D16	15CDC*D16	15	28	21	14	245	C	A
HT30C3D1-D16	30CDC*D16	30	32	26.5	17	340	C	B
HT45C3D1-D16	45CDC*D16	45	32	26.5	17	405	C	B
HT75C3D1-D16	75CDC*D16	75	38.5	28.5	20	555	C	B+
HT112C3D1-D16	112CDC*D16	112	40.5	31.5	27.75	765	C	C
HT150C3D1-D16	150CDC*D16	150	40.5	36.5	21.75	910	C	C+
HT225C3D1-D16	225CDC*D16	225	51.5	40.5	26.5	1600	C	D
HT300C3D1-D16	300CDC*D16	300	51.5	40.5	26.5	2030	C	D
HT500C3D1-D16	500CDC*D16	500	66	50.5	32	2850	C	E
HT750C3D1-D16	750CDC*D16	750	80.25	64	44.25	3860	J	F
HT1000C3D1-D16	1000CDC*D16	1000	80.25	64	44.25	5100	J	F

Copper | Primary: 480D | Secondary: 380Y/220, 400Y/231, 416Y/240, 430Y/248 | 150CRise | K1

Catalog Number	Alt #	kVA	Width (Inches)	Depth (Inches)	Height (Inches)	Weight (Lbs)	Wiring Diagram	Dimension Drawing
HT15A3XZ1-D16	15AXZC*D16	15	28	21	14	245	H	A
HT30A3XZ1-D16	30AXZC*D16	30	32	26.5	17	340	H	B
HT45A3XZ1-D16	45AXZC*D16	45	32	26.5	17	405	H	B
HT75A3XZ1-D16	75AXZC*D16	75	38.5	28.5	20	555	H	B+
HT112A3XZ1-D16	112AXZC*D16	112	40.5	31.5	27.75	765	H	C
HT150A3XZ1-D16	150AXZC*D16	150	40.5	36.5	21.75	910	H	C+
HT225A3XZ1-D16	225AXZC*D16	225	51.5	40.5	26.5	1600	H	D
HT300A3XZ1-D16	300AXZC*D16	300	51.5	40.5	26.5	2030	H	D
HT500A3XZ1-D16	500AXZC*D16	500	66	50.5	32	2850	H	E
HT750A3XZ1-D16	750AXZC*D16	750	80.25	64	44.25	3860	H	F
HT1000A3XZ1-D16	1000AXZC*D16	1000	80.25	64	44.25	5100	H	F

Copper | Primary: 480D | Secondary: 480Y/277 | 150CRise | K1

Catalog Number	Alt #	kVA	Width (Inches)	Depth (Inches)	Height (Inches)	Weight (Lbs)	Wiring Diagram	Dimension Drawing
HT15A3D1-D16	15ADC*D16	15	28	21	14	245	A	A
HT30A3D1-D16	30ADC*D16	30	32	26.5	17	340	A	B
HT45A3D1-D16	45ADC*D16	45	32	26.5	17	405	A	B
HT75A3D1-D16	75ADC*D16	75	38.5	28.5	20	555	A	B+
HT112A3D1-D16	112ADC*D16	112	40.5	31.5	27.75	765	A	C
HT150A3D1-D16	150ADC*D16	150	40.5	36.5	21.75	910	A	C+
HT225A3D1-D16	225ADC*D16	225	51.5	40.5	26.5	1600	A	D
HT300A3D1-D16	300ADC*D16	300	51.5	40.5	26.5	2030	A	D
HT500A3D1-D16	500ADC*D16	500	66	50.5	32	2850	A	E
HT750A3D1-D16	750ADC*D16	750	80.25	64	44.25	3860	K	F
HT1000A3D1-D16	1000ADC*D16	1000	80.25	64	44.25	5100	K	F

General Purpose - Copper — 3 Phase

Copper | Primary: 600D | Secondary: 208Y/120 | 150CRise | K1

Catalog Number	Alt #	kVA	Width (Inches)	Depth (Inches)	Height (Inches)	Weight (Lbs)	Wiring Diagram	Dimension Drawing
HT15F3B1-D16	15FBC*D16	15	28	21	14	245	A	A
HT30F3B1-D16	30FBC*D16	30	32	26.5	17	340	A	B
HT45F3B1-D16	45FBC*D16	45	32	26.5	17	405	A	B
HT75F3B1-D16	75FBC*D16	75	38.5	28.5	20	555	A	B+
HT112F3B1-D16	112FBC*D16	112	40.5	31.5	27.75	765	A	C
HT150F3B1-D16	150FBC*D16	150	40.5	36.5	21.75	910	A	C+
HT225F3B1-D16	225FBC*D16	225	51.5	40.5	26.5	1600	A	D
HT300F3B1-D16	300FBC*D16	300	51.5	40.5	26.5	2030	A	D
HT500F3B1-D16	500FBC*D16	500	66	50.5	32	2850	A	E
HT750F3B1-D16	750FBC*D16	750	80.25	64	44.25	3860	K	F
HT1000F3B1-D16	1000FBC*D16	1000	80.25	64	44.25	5100	K	F

Copper | Primary: 600D | Secondary: 480Y/277 | 150CRise | K1

Catalog Number	Alt #	kVA	Width (Inches)	Depth (Inches)	Height (Inches)	Weight (Lbs)	Wiring Diagram	Dimension Drawing
HT15F3D1-D16	15FDC*D16	15	28	21	14	245	A	A
HT30F3D1-D16	30FDC*D16	30	32	26.5	17	340	A	B
HT45F3D1-D16	45FDC*D16	45	32	26.5	17	405	A	B
HT75F3D1-D16	75FDC*D16	75	38.5	28.5	20	555	A	B+
HT112F3D1-D16	112FDC*D16	112	40.5	31.5	27.75	765	A	C
HT150F3D1-D16	150FDC*D16	150	40.5	36.5	21.75	910	A	C+
HT225F3D1-D16	225FDC*D16	225	51.5	40.5	26.5	1600	A	D
HT300F3D1-D16	300FDC*D16	300	51.5	40.5	26.5	2030	A	D
HT500F3D1-D16	500FDC*D16	500	66	50.5	32	2850	A	E
HT750F3D1-D16	750FDC*D16	750	80.25	64	44.25	3860	K	F
HT1000F3D1-D16	1000FDC*D16	1000	80.25	64	44.25	5100	K	F

K-Factor 4 - Aluminum — 3 Phase

Aluminum | Primary: 480D | Secondary: 208Y/120 | 150CRise | K4 | Shielded

Catalog Number	Alt #	kVA	Width (Inches)	Depth (Inches)	Height (Inches)	Weight (Lbs)	Wiring Diagram	Dimension Drawing
HT15A3B2SH-HK04	15YS4*D16	15	28	21	14	245	A	A
HT30A3B2SH-HK04	30YS4*D16	30	32	26.5	17	340	A	B
HT45A3B2SH-HK04	45YS4*D16	45	38.5	28.5	20	425	A	B+
HT75A3B2SH-HK04	75YS4*D16	75	40.5	31.5	27.75	615	A	C
HT112A3B2SH-HK04	112YS4*D16	112	40.5	31.5	27.75	770	A	C
HT150A3B2SH-HK04	150YS4*D16	150	40.5	36.5	21.75	990	A	C+
HT225A3B2SH-HK04	225YS4*D16	225	51.5	40.5	26.5	1730	A	D
HT300A3B2SH-HK04	300YS4*D16	300	66	50.5	32	2050	A	E
HT500A3B2SH-HK04	500YS4*D16	500	66	50.5	32	2950	A	E
HT750A3B2SH-HK04	750YS4*D16	750	80.25	64	44.25	4300	K	F
HT1000A3B2SH-HK04	1000YS4*D16	1000	80.25	64	44.25	7500	K	F

Aluminum | Primary: 480D | Secondary: 480Y/277 | 150CRise | K4 | Shielded

Catalog Number	Alt #	kVA	Width (Inches)	Depth (Inches)	Height (Inches)	Weight (Lbs)	Wiring Diagram	Dimension Drawing
HT15A3D2SH-HK04	15AD4*D16	15	28	21	14	245	A	A
HT30A3D2SH-HK04	30AD4*D16	30	32	26.5	17	340	A	B
HT45A3D2SH-HK04	45AD4*D16	45	38.5	28.5	20	425	A	B+
HT75A3D2SH-HK04	75AD4*D16	75	40.5	31.5	27.75	615	A	C
HT112A3D2SH-HK04	112AD4*D16	112	40.5	31.5	27.75	770	A	C
HT150A3D2SH-HK04	150AD4*D16	150	40.5	36.5	21.75	990	A	C+
HT225A3D2SH-HK04	225AD4*D16	225	51.5	40.5	26.5	1730	A	D
HT300A3D2SH-HK04	300AD4*D16	300	66	50.5	32	2050	A	E
HT500A3D2SH-HK04	500AD4*D16	500	66	50.5	32	2950	A	E
HT750A3D2SH-HK04	750AD4*D16	750	80.25	64	44.25	4300	K	F
HT1000A3D2SH-HK04	1000AD4*D16	1000	80.25	64	44.25	7500	K	F

Aluminum | Primary: 600D | Secondary: 208Y/120 | 150CRise | K4 | Shielded

Catalog Number	Alt #	kVA	Width (Inches)	Depth (Inches)	Height (Inches)	Weight (Lbs)	Wiring Diagram	Dimension Drawing
HT15F3B2SH-HK04	15FB4*D16	15	28	21	14	245	A	A
HT30F3B2SH-HK04	30FB4*D16	30	32	26.5	17	340	A	B
HT45F3B2SH-HK04	45FB4*D16	45	38.5	28.5	20	425	A	B+
HT75F3B2SH-HK04	75FB4*D16	75	40.5	31.5	27.75	615	A	C
HT112F3B2SH-HK04	112FB4*D16	112	40.5	31.5	27.75	770	A	C
HT150F3B2SH-HK04	150FB4*D16	150	40.5	36.5	21.75	990	A	C+
HT225F3B2SH-HK04	225FB4*D16	225	51.5	40.5	26.5	1730	A	D
HT300F3B2SH-HK04	300FB4*D16	300	66	50.5	32	2050	A	E
HT500F3B2SH-HK04	500FB4*D16	500	66	50.5	32	2950	A	E
HT750F3B2SH-HK04	750FB4*D16	750	80.25	64	44.25	4300	K	F
HT1000F3B2SH-HK04	1000FB4*D16	1000	80.25	64	44.25	7500	K	F

K-Factor 4 - Aluminum — 3 Phase

Aluminum Primary: 600D Secondary: 480Y/277 150CRise K4 Shielded								
Catalog Number	Alt #	kVA	Width (Inches)	Depth (Inches)	Height (Inches)	Weight (Lbs)	Wiring Diagram	Dimension Drawing
HT15F3D2SH-HK04	15FD4*D16	15	28	21	14	245	A	A
HT30F3D2SH-HK04	30FD4*D16	30	32	26.5	17	340	A	B
HT45F3D2SH-HK04	45FD4*D16	45	38.5	28.5	20	425	A	B+
HT75F3D2SH-HK04	75FD4*D16	75	40.5	31.5	27.75	615	A	C
HT112F3D2SH-HK04	112FD4*D16	112	40.5	31.5	27.75	770	A	C
HT150F3D2SH-HK04	150FD4*D16	150	40.5	36.5	21.75	990	A	C+
HT225F3D2SH-HK04	225FD4*D16	225	51.5	40.5	26.5	1730	A	D
HT300F3D2SH-HK04	300FD4*D16	300	66	50.5	32	2050	A	E
HT500F3D2SH-HK04	500FD4*D16	500	66	50.5	32	2950	A	E
HT750F3D2SH-HK04	750FD4*D16	750	80.25	64	44.25	4300	K	F
HT1000F3D2SH-HK04	1000FD4*D16	1000	80.25	64	44.25	7500	K	F

K-Factor 9 - Aluminum — 3 Phase

Aluminum Primary: 480D Secondary: 208Y/120 150CRise K9 Shielded								
Catalog Number	Alt #	kVA	Width (Inches)	Depth (Inches)	Height (Inches)	Weight (Lbs)	Wiring Diagram	Dimension Drawing
HT15A3B2SH-HK09	15YS9 *D16	15	28	21	14	265	A	A
HT30A3B2SH-HK09	30YS9 *D16	30	32	26.5	17	350	A	B
HT45A3B2SH-HK09	45YS9 *D16	45	38.5	28.5	20	470	A	B+
HT75A3B2SH-HK09	75YS9 *D16	75	40.5	31.5	27.75	650	A	C
HT112A3B2SH-HK09	112YS9 *D16	112	40.5	36.5	21.75	850	A	C+
HT150A3B2SH-HK09	150YS9 *D16	150	51.5	40.5	26.5	1200	A	D
HT225A3B2SH-HK09	225YS9 *D16	225	51.5	40.5	26.5	1940	A	D
HT300A3B2SH-HK09	300YS9 *D16	300	66	50.5	32	2700	A	E
HT500A3B2SH-HK09	500YS9 *D16	500	80.25	64	44.25	3380	A	F
HT750A3B2SH-HK09	750YS9 *D16	750	80.25	64	44.25	4900	K	F
HT1000A3B2SH-HK09	1000YS9 *D16	1000	80.25	64	44.25	7500	K	F

Aluminum Primary: 480D Secondary: 480Y/277 150CRise K9 Shielded								
Catalog Number	Alt #	kVA	Width (Inches)	Depth (Inches)	Height (Inches)	Weight (Lbs)	Wiring Diagram	Dimension Drawing
HT15A3D2SH-HK09	15AD9 *D16	15	28	21	14	265	A	A
HT30A3D2SH-HK09	30AD9 *D16	30	32	26.5	17	350	A	B
HT45A3D2SH-HK09	45AD9 *D16	45	38.5	28.5	20	470	A	B+
HT75A3D2SH-HK09	75AD9 *D16	75	40.5	31.5	27.75	650	A	C
HT112A3D2SH-HK09	112AD9 *D16	112	40.5	36.5	21.75	850	A	C+
HT150A3D2SH-HK09	150AD9 *D16	150	51.5	40.5	26.5	1200	A	D
HT225A3D2SH-HK09	225AD9 *D16	225	51.5	40.5	26.5	1940	A	D
HT300A3D2SH-HK09	300AD9 *D16	300	66	50.5	32	2700	A	E
HT500A3D2SH-HK09	500AD9 *D16	500	80.25	64	44.25	3380	A	F
HT750A3D2SH-HK09	750AD9 *D16	750	80.25	64	44.25	4900	K	F
HT1000A3D2SH-HK09	1000AD9 *D16	1000	80.25	64	44.25	7500	K	F

K-Factor 9 - Aluminum — 3 Phase

Aluminum Primary: 600D Secondary: 480Y/277 150CRise K9 Shielded								
Catalog Number	Alt #	kVA	Width (Inches)	Depth (Inches)	Height (Inches)	Weight (Lbs)	Wiring Diagram	Dimension Drawing
HT15F3D2SH-HK09	15FD9 *D16	15	28	21	14	265	A	A
HT30F3D2SH-HK09	30FD9 *D16	30	32	26.5	17	350	A	B
HT45F3D2SH-HK09	45FD9 *D16	45	38.5	28.5	20	470	A	B+
HT75F3D2SH-HK09	75FD9 *D16	75	40.5	31.5	27.75	650	A	C
HT112F3D2SH-HK09	112FD9 *016	112	40.5	36.5	21.75	850	A	C+
HT150F3D2SH-HK09	150FD9 *D16	150	51.5	40.5	26.5	1200	A	D
HT225F3D2SH-HK09	225FD9 *D16	225	51.5	40.5	26.5	1940	A	D
HT300F3D2SH-HK09	300FD9 *D16	300	66	50.5	32	2700	A	E
HT500F3D2SH-HK09	500FD9 *016	500	80.25	64	44.25	3380	A	F
HT750F3D2SH-HK09	750FD9 *D16	750	80.25	64	44.25	4900	K	F
HT1000F3D2SH-HK09	1000FD9 *D16	1000	80.25	64	44.25	7500	K	F

Aluminum Primary: 600D Secondary: 208Y/120 150CRise K9 Shielded								
Catalog Number	Alt #	kVA	Width (Inches)	Depth (Inches)	Height (Inches)	Weight (Lbs)	Wiring Diagram	Dimension Drawing
HT15F3B2SH-HK09	15FB9 *D16	15	28	21	14	265	A	A
HT30F3B2SH-HK09	30FB9 *D16	30	32	26.5	17	350	A	B
HT45F3B2SH-HK09	45FB9 *D16	45	38.5	28.5	20	470	A	B+
HT75F3 B2SH_HK09	75FB9 *D16	75	40.5	31.5	27.75	650	A	C
HT112F3B2SH-HK09	112FB9 *D16	112	40.5	36.5	21.75	850	A	C+
HT150F3B2SH-HK09	150FB9 *D16	150	51.5	40.5	26.5	1200	A	D
HT225F3B2SH-HK09	225FB9 *D16	225	51.5	40.5	26.5	1940	A	D
HT300F3B2SH-HK09	300FB9 *D16	300	66	50.5	32	2700	A	E
HT500F3B2SH-HK09	500FB9 *D16	500	80.25	64	44.25	3380	A	F
HT750F3B2SH-HK09	750FB9 *D16	750	80.25	64	44.25	4900	K	F
HT1000F3B2SH-HK09	1000FB9 *D16	1000	80.25	64	44.25	7500	K	F

K-Factor 13 - Aluminum — 3 Phase

Aluminum Primary: 480D Secondary: 208Y/120 150CRise K13 Shielded								
Catalog Number	Alt #	kVA	Width (Inches)	Depth (Inches)	Height (Inches)	Weight (Lbs)	Wiring Diagram	Dimension Drawing
HT15A3B2SH-HK13	15YS13*D16	15	28	21	14	265	A	A
HT30A3B2SH-HK13	30YS13*D16	30	32	26.5	17	350	A	B
HT45A3B2SH-HK13	45YS13*D16	45	38.5	28.5	20	470	A	B+
HT75A3B2SH-HK13	75YS13*D16	75	40.5	31.5	27.75	650	A	C
HT112A3B2SH-HK13	112YS13*D16	112	40.5	36.5	21.75	850	A	C+
HT150A3B2SH-HK13	150YS13*D16	150	51.5	40.5	26.5	1200	A	D
HT225A3B2SH-HK13	225YS13*D16	225	51.5	40.5	26.5	1940	A	D
HT300A3B2SH-HK13	300YS13*D16	300	66	50.5	32	2700	A	E
HT500A3B2SH-HK13	500YS13*D16	500	80.25	64	44.25	3380	A	F
HT750A3B2SH-HK13	750YS13*D16	750	80.25	64	44.25	4900	K	F
HT1000A3B2SH-HK13	1000YS13*D16	1000	80.25	64	44.25	7500	K	F

K-Factor 13 - Aluminum — 3 Phase

Aluminum | Primary: 480D | Secondary: 480Y/277 | 150CRise | K13 | Shielded

<i>Catalog Number</i>	<i>Alt #</i>	<i>kVA</i>	<i>Width (Inches)</i>	<i>Depth (Inches)</i>	<i>Height (Inches)</i>	<i>Weight (Lbs)</i>	<i>Wiring Diagram</i>	<i>Dimension Drawing</i>
HT15A3D2SH-HK13	15AD13*D16	15	28	21	14	265	A	A
HT30A3D2SH-HK13	30AD13*D16	30	32	26.5	17	350	A	B
HT45A3D2SH-HK13	45AD13*D16	45	38.5	28.5	20	470	A	B+
HT75A3D2SH-HK13	75AD13*D16	75	40.5	31.5	27.75	650	A	C
HT112A3D2SH-HK13	112AD13*D16	112	40.5	36.5	21.75	850	A	C+
HT150A3D2SH-HK13	150AD13*D16	150	51.5	40.5	26.5	1200	A	D
HT225A3D2SH-HK13	225AD13*D16	225	51.5	40.5	26.5	1940	A	D
HT300A3D2SH-HK13	300AD13*D16	300	66	50.5	32	2700	A	E
HT500A3D2SH-HK13	500AD13*D16	500	80.25	64	44.25	3380	A	F
HT750A3D2SH-HK13	750AD13*D16	750	80.25	64	44.25	4900	K	F
HT1000A3D2SH-HK13	1000AD13*D16	1000	80.25	64	44.25	7500	K	F

Aluminum | Primary: 600D | Secondary: 480Y/277 | 150CRise | K13 | Shielded

<i>Catalog Number</i>	<i>Alt #</i>	<i>kVA</i>	<i>Width (Inches)</i>	<i>Depth (Inches)</i>	<i>Height (Inches)</i>	<i>Weight (Lbs)</i>	<i>Wiring Diagram</i>	<i>Dimension Drawing</i>
HT15F3D2SH-HK13	15FD13*D16	15	28	21	14	265	A	A
HT30F3D2SH-HK13	30FD13*D16	30	32	26.5	17	350	A	B
HT45F3D2SH-HK13	45FD13*D16	45	38.5	28.5	20	470	A	B+
HT75F3D2SH-HK13	75FD13*D16	75	40.5	31.5	27.75	650	A	C
HT112F3D2SH-HK13	112FD13*D16	112	40.5	36.5	21.75	850	A	C+
HT150F3D2SH-HK13	150FD13*D16	150	51.5	40.5	26.5	1200	A	D
HT225F3D2SH-HK13	225FD13*D16	225	51.5	40.5	26.5	1940	A	D
HT300F3D2SH-HK13	300FD13*D16	300	66	50.5	32	2700	A	E
HT500F3D2SH-HK13	500FD13*D16	500	80.25	64	44.25	3380	A	F
HT750F3D2SH-HK13	750FD13*D16	750	80.25	64	44.25	4900	K	F
HT1000F3D2SH-HK13	1000FD13*D16	1000	80.25	64	44.25	7500	K	F

Aluminum | Primary: 600D | Secondary: 208Y/120 | 150CRise | K13 | Shielded

<i>Catalog Number</i>	<i>Alt #</i>	<i>kVA</i>	<i>Width (Inches)</i>	<i>Depth (Inches)</i>	<i>Height (Inches)</i>	<i>Weight (Lbs)</i>	<i>Wiring Diagram</i>	<i>Dimension Drawing</i>
HT15F3B2SH-HK13	15FB13*D16	15	28	21	14	265	A	A
HT30F3B2SH-HK13	30FB13*D16	30	32	26.5	17	350	A	B
HT45F3B2SH-HK13	45FB13*D16	45	38.5	28.5	20	470	A	B+
HT75F3B2SH-HK13	75FB13*D16	75	40.5	31.5	27.75	650	A	C
HT112F3B2SH-HK13	112FB13*D16	112	40.5	36.5	21.75	850	A	C+
HT150F3B2SH-HK13	150FB13*D16	150	51.5	40.5	26.5	1200	A	D
HT225F3B2SH-HK13	225FB13*D16	225	51.5	40.5	26.5	1940	A	D
HT300F3B2SH-HK13	300FB13*D16	300	66	50.5	32	2700	A	E
HT500F3B2SH-HK13	500FB13*D16	500	80.25	64	44.25	3380	A	F
HT750F3B2SH-HK13	750FB13*D16	750	80.25	64	44.25	4900	K	F
HT1000F3B2SH-HK13	1000FB13*D16	1000	80.25	64	44.25	7500	K	F

K-Factor 4 - Copper — 3 Phase

Copper | Primary: 480D | Secondary: 208Y/120 | 150CRise | K4 | Shielded

Catalog Number	Alt #	kVA	Width (Inches)	Depth (Inches)	Height (Inches)	Weight (Lbs)	Wiring Diagram	Dimension Drawing
HT15A3BISH-HK04	15YSSHC*D16	15	28	21	14	250	A	A
HT30A3BISH-HK04	30YSC4*D16	30	32	26.5	17	345	A	B
HT45A3BISH-HK04	45YSC4*D16	45	38.5	28.5	20	430	A	B+
HT75A3BISH-HK04	75YSC4*D16	75	40.5	31.5	27.75	625	A	C
HT112A3BISH-HK04	112YSC4*D16	112	40.5	31.5	21.75	780	A	C
HT150A3BISH-HK04	150YSC4*D16	150	40.5	36.5	26.5	1010	A	C+
HT225A3BISH-HK04	225YSC4*D16	225	51.5	40.5	26.5	1750	A	D
HT300A3BISH-HK04	300YSC4*D16	300	66	50.5	32	2080	A	E
HT500A3BISH-HK04	500YSC4*D16	500	66	50.5	32	3000	A	E
HT750A3BISH-HK04	750YSC4*D16	750	80.25	64	44.25	4400	K	F
HT1000A3BISH-HK04	1000YSC4*D16	1000	80.25	64	44.25	7500	K	F

Copper | Primary: 480D | Secondary: 480Y/277 | 150CRise | K4 | Shielded

Catalog Number	Alt #	kVA	Width (Inches)	Depth (Inches)	Height (Inches)	Weight (Lbs)	Wiring Diagram	Dimension Drawing
HT15A3DISH-HK04	15ADC4*D16	15	28	21	14	250	A	A
HT30A3DISH-HK04	30ADC4*D16	30	32	26.5	17	345	A	B
HT45A3DISH-HK04	45ADC4*D16	45	38.5	28.5	20	430	A	B+
HT75A3DISH-HK04	75ADC4*D16	75	40.5	31.5	27.75	625	A	C
HT112A3DISH-HK04	112ADC4*D16	112	40.5	31.5	21.75	780	A	C
HT150A3DISH-HK04	150ADC4*D16	150	40.5	36.5	26.5	1010	A	C+
HT225A3DISH-HK04	225ADC4*D16	225	51.5	40.5	26.5	1750	A	D
HT300A3DISH-HK04	300ADC4*D16	300	66	50.5	32	2080	A	E
HT500A3DISH-HK04	500ADC4*D16	500	66	50.5	32	3000	A	E
HT750A3DISH-HK04	750ADC4*D16	750	80.25	64	44.25	4400	K	F
HT1000A3DISH-HK04	1000ADC4*D16	1000	80.25	64	44.25	7500	K	F

Copper | Primary: 600D | Secondary: 208Y/120 | 150CRise | K4 | Shielded

Catalog Number	Alt #	kVA	Width (Inches)	Depth (Inches)	Height (Inches)	Weight (Lbs)	Wiring Diagram	Dimension Drawing
HT15F3BISH-HK04	15FBC4*D16	15	28	21	14	250	A	A
HT30F3BISH-HK04	30FBC4*D16	30	32	26.5	17	345	A	B
HT45F3BISH-HK04	45FBC4*D16	45	38.5	28.5	20	430	A	B+
HT75F3BISH-HK04	75FBC4*D16	75	40.5	31.5	27.75	625	A	C
HT112F3BISH-HK04	112FBC4*D16	112	40.5	31.5	21.75	780	A	C
HT150F3BISH-HK04	150FBC4*D16	150	40.5	36.5	26.5	1010	A	C+
HT225F3BISH-HK04	225FBC4*D16	225	51.5	40.5	26.5	1750	A	D
HT300F3BISH-HK04	300FBC4*D16	300	66	50.5	32	2080	A	E
HT500F3BISH-HK04	500FBC4*D16	500	66	50.5	32	3000	A	E
HT750F3BISH-HK04	750FBC4*D16	750	80.25	64	44.25	4400	K	F
HT1000F3BISH-HK04	1000FBC4*D16	1000	80.25	64	44.25	7500	K	F

K-Factor 4 - Copper — 3 Phase

Copper | Primary: 600D | Secondary: 480Y/277 | 150CRise | K4 | Shielded

Catalog Number	Alt #	kVA	Width (Inches)	Depth (Inches)	Height (Inches)	Weight (Lbs)	Wiring Diagram	Dimension Drawing
HT15F3DISH-HK04	15FDC4*D16	15	28	21	14	250	A	A
HT30F3DISH-HK04	30FDC4*D16	30	32	26.5	17	345	A	B
HT45F3DISH-HK04	45FDC4*D16	45	38.5	28.5	20	430	A	B+
HT75F3DISH-HK04	75FDC4*D16	75	40.5	31.5	27.75	625	A	C
HT112F3DISH-HK04	112FDC4*D16	112	40.5	31.5	21.75	780	A	C
HT150F3DISH-HK04	150FDC4*D16	150	40.5	36.5	26.5	1010	A	C+
HT225F3DISH-HK04	225FDC4*D16	225	51.5	40.5	26.5	1750	A	D
HT300F3DISH-HK04	300FDC4*D16	300	66	50.5	32	2080	A	E
HT500F3DISH-HK04	500FDC4*D16	500	66	50.5	32	3000	A	E
HT750F3DISH-HK04	750FDC4*D16	750	80.25	64	44.25	4400	K	F
HT1000F3DISH-HK04	1000FDC4*D16	1000	80.25	64	44.25	7500	K	F

K-Factor 9 - Copper — 3 Phase

Copper | Primary: 480D | Secondary: 208Y/120 | 150CRise | K9 | Shielded

Catalog Number	Alt #	kVA	Width (Inches)	Depth (Inches)	Height (Inches)	Weight (Lbs)	Wiring Diagram	Dimension Drawing
HT15A3BISH-HK09	15YSC9*D16	15	28	21	14	270	A	A
HT30A3BISH-HK09	30YSC9*D16	30	32	26.5	17	360	A	B
HT45A3BISH-HK09	45YSC9*D16	45	38.5	28.5	20	480	A	B+
HT75A3BISH-HK09	75YSC9*D16	75	40.5	31.5	27.75	660	A	C
HT112A3BISH-HK09	112YSC9*D16	112	40.5	36.5	21.75	865	A	C+
HT150A3BISH-HK09	150YSC9*D16	150	51.5	40.5	26.5	1280	A	D
HT225A3BISH-HK09	225YSC9*D16	225	51.5	40.5	26.5	1960	A	D
HT300A3BISH-HK09	300YSC9*D16	300	66	50.5	32	2750	A	E
HT500A3BISH-HK09	500YSC9*D16	500	80.25	64	44.25	3430	A	F
HT750A3BISH-HK09	750YSC9*D16	750	80.25	64	44.25	5000	K	F
HT1000A3BISH-HK09	1000YSC9*D16	1000	80.25	64	44.25	7600	K	F

Copper | Primary: 480D | Secondary: 480Y/277 | 150CRise | K9 | Shielded

Catalog Number	Alt #	kVA	Width (Inches)	Depth (Inches)	Height (Inches)	Weight (Lbs)	Wiring Diagram	Dimension Drawing
HT15A3DISH-HK09	15ADC9*D16	15	28	21	14	270	A	A
HT30A3DISH-HK09	30ADC9*D16	30	32	26.5	17	360	A	B
HT45A3DISH-HK09	45ADC9*D16	45	38.5	28.5	20	480	A	B+
HT75A3DISH-HK09	75ADC9*D16	75	40.5	31.5	27.75	660	A	C
HT112A3DISH-HK09	112ADC9*D16	112	40.5	36.5	21.75	865	A	C+
HT150A3DISH-HK09	150ADC9*D16	150	51.5	40.5	26.5	1280	A	D
HT225A3DISH-HK09	225ADC9*D16	225	51.5	40.5	26.5	1960	A	D
HT300A3DISH-HK09	300ADC9*D16	300	66	50.5	32	2750	A	E
HT500A3DISH-HK09	500ADC9*D16	500	80.25	64	44.25	3430	A	F
HT750A3DISH-HK09	750ADC9*D16	750	80.25	64	44.25	5000	K	F
HT1000A3DISH-HK09	1000ADC9*D16	1000	80.25	64	44.25	7600	K	F

K-Factor 9 - Copper — 3 Phase

Copper | Primary: 600D | Secondary: 480Y/277 | 150CRise | K9 | Shielded

Catalog Number	Alt #	kVA	Width (Inches)	Depth (Inches)	Height (Inches)	Weight (Lbs)	Wiring Diagram	Dimension Drawing
HT15F3DISH-HK09	15FDC9*D16	15	28	21	14	270	A	A
HT30F3DISH-HK09	30FDC9*D16	30	32	26.5	17	360	A	B
HT45F3DISH-HK09	45FDC9*D16	45	38.5	28.5	20	480	A	B+
HT75F3DISH-HK09	75FDC9*D16	75	40.5	31.5	27.75	660	A	C
HT112F3DISH-HK09	112FDC9*D16	112	40.5	36.5	21.75	865	A	C+
HT150F3DISH-HK09	150FDC9*D16	150	51.5	40.5	26.5	1280	A	D
HT225F3DISH-HK09	225FDC9*D16	225	51.5	40.5	26.5	1960	A	D
HT300F3DISH-HK09	300FDC9*D16	300	66	50.5	32	2750	A	E
HT500F3DISH-HK09	500FDC9*D16	500	80.25	64	44.25	3430	A	F
HT750F3DISH-HK09	750FDC9*D16	750	80.25	64	44.25	5000	K	F
HT1000F3DISH-HK09	1000FDC9*D16	1000	80.25	64	44.25	7600	K	F

Copper | Primary: 600D | Secondary: 208Y/120 | 150CRise | K9 | Shielded

Catalog Number	Alt #	kVA	Width (Inches)	Depth (Inches)	Height (Inches)	Weight (Lbs)	Wiring Diagram	Dimension Drawing
HT15F3BISH-HK09	15FBC9*D16	15	28	21	14	270	A	A
HT30F3BISH-HK09	30FBC9*D16	30	32	26.5	17	360	A	B
HT45F3BISH-HK09	45FBC9*D16	45	38.5	28.5	20	480	A	B+
HT75F3BISH-HK09	75FBC9*D16	75	40.5	31.5	27.75	660	A	C
HT112F3BISH-HK09	112FBC9*D16	112	40.5	36.5	21.75	865	A	C+
HT150F3BISH-HK09	150FBC9*D16	150	51.5	40.5	26.5	1280	A	D
HT225F3BISH-HK09	225FBC9*D16	225	51.5	40.5	26.5	1960	A	D
HT300F3BISH-HK09	300FBC9*D16	300	66	50.5	32	2750	A	E
HT500F3BISH-HK09	500FBC9*D16	500	80.25	64	44.25	3430	A	F
HT750F3BISH-HK09	750FBC9*D16	750	80.25	64	44.25	5000	K	F
HT1000F3BISH-HK09	1000FBC9*D16	1000	80.25	64	44.25	7600	K	F

K-Factor 13 - Copper — 3 Phase

Copper | Primary: 480D | Secondary: 208Y/120 | 150CRise | K13 | Shielded

Catalog Number	Alt #	kVA	Width (Inches)	Depth (Inches)	Height (Inches)	Weight (Lbs)	Wiring Diagram	Dimension Drawing
HT15A3BISH-HK13	15YSC13*D16	15	28	21	14	270	A	A
HT30A3BISH-HK13	30YSC13*D16	30	32	26.5	17	360	A	B
HT45A3BISH-HK13	45YSC13*D16	45	38.5	28.5	20	480	A	B+
HT75A3BISH-HK13	75YSC13*D16	75	40.5	31.5	27.75	660	A	C
HT112A3BISH-HK13	112YSC13*D16	112	40.5	36.5	21.75	865	A	C+
I-IT150A3BISH-HK13	150YSC13*D16	150	51.5	40.5	26.5	1280	A	D
HT225A3BISH-HK13	225YSC13*D16	225	51.5	40.5	26.5	1960	A	D
HT300A3BISH-HK13	300YSC13*D16	300	66	50.5	32	2750	A	E
HT500A3BISH-HK13	500YSC13*D16	500	80.25	64	44.25	3430	A	F
HT750A3BISH-HK13	750YSC13*D16	750	80.25	64	44.25	5000	K	F
HT1000A3BISH-HK13	1000YSC13*D16	1000	80.25	64	44.25	7600	K	F

K-Factor 13 - Copper — 3 Phase

Copper | Primary: 480D | Secondary: 480Y/277 | 150CRise | K13 | Shielded

Catalog Number	Alt #	kVA	Width (Inches)	Depth (Inches)	Height (Inches)	Weight (Lbs)	Wiring Diagram	Dimension Drawing
HT15A3DISH-HK13	15ADC13*D16	15	28	21	14	270	A	A
HT30A3DISH-HK13	30ADC13*D16	30	32	26.5	17	360	A	B
HT45A3DISH-HK13	45ADC13*D16	45	38.5	28.5	20	480	A	B+
HT75A3DISH-HK13	75ADC13*D16	75	40.5	31.5	27.75	660	A	C
HT112A3DISH-HK13	112ADC13*D16	112	40.5	36.5	21.75	865	A	C+
HT150A3DISH-HK13	150ADC13*D16	150	51.5	40.5	26.5	1280	A	D
HT225A3DISH-HK13	225ADC13*D16	225	51.5	40.5	26.5	1960	A	D
HT300A3DISH-HK13	300ADC13*D16	300	66	50.5	32	2750	A	E
HT500A3DISH-HK13	500ADC13*D16	500	80.25	64	44.25	3430	A	F
HT750A3DISH-HK13	750ADC13*D16	750	80.25	64	44.25	5000	K	F
HT1000A3DISH-HK13	1000ADC13*D16	1000	80.25	64	44.25	7600	K	F

Copper | Primary: 600D | Secondary: 480Y/277 | 150CRise | K13 | Shielded

Catalog Number	Alt #	kVA	Width (Inches)	Depth (Inches)	Height (Inches)	Weight (Lbs)	Wiring Diagram	Dimension Drawing
HT15F3DISH-HK13	15FDC13*D16	15	28	21	14	270	A	A
HT30F3DISH-HK13	30FDC13*D16	30	32	26.5	17	360	A	B
HT45F3DISH-HK13	45FDC13*D16	45	38.5	28.5	20	480	A	B+
HT75F3DISH-HK13	75FDC13*D16	75	40.5	31.5	27.75	660	A	C
HT112F3DISH-HK13	112FDC13*D16	112	40.5	36.5	21.75	865	A	C+
HT150F3DISH-HK13	150FDC13*D16	150	51.5	40.5	26.5	1280	A	D
HT225F3DISH-HK13	225FDC13*D16	225	51.5	40.5	26.5	1960	A	D
HT300F3DISH-HK13	300FDC13*D16	300	66	50.5	32	2750	A	E
HT500F3DISH-HK13	500FDC13*D16	500	80.25	64	44.25	3430	A	F
HT750F3DISH-HK13	750FDC13*D16	750	80.25	64	44.25	5000	K	F
HT1000F3DISH-HK13	1000FDC13*D16	1000	80.25	64	44.25	7600	K	F

Copper | Primary: 600D | Secondary: 208Y/120 | 150CRise | K13 | Shielded

Catalog Number	Alt #	kVA	Width (Inches)	Depth (Inches)	Height (Inches)	Weight (Lbs)	Wiring Diagram	Dimension Drawing
HT15F3BISH-HK13	15FBC13*D16	15	28	21	14	270	A	A
HT30F3BISH-HK13	30FBC13*D16	30	32	26.5	17	360	A	B
HT45F3BISH-HK13	45FBC13*D16	45	38.5	28.5	20	480	A	B+
HT75F3BISH-HK13	75FBC13*D16	75	40.5	31.5	27.75	660	A	C
HT112F3BISH-HK13	112FBC13*D16	112	40.5	36.5	21.75	865	A	C+
HT150F3BISH-HK13	150FBC13*D16	150	51.5	40.5	26.5	1280	A	D
HT225F3BISH-HK13	225FBC13*D16	225	51.5	40.5	26.5	1960	A	D
HT300F3BISH-HK13	300FBC13*D16	300	66	50.5	32	2750	A	E
HT500F3BISH-HK13	500FBC13*D16	500	80.25	64	44.25	3430	A	F
HT750F3BISH-HK13	750FBC13*D16	750	80.25	64	44.25	5000	K	F
HT1000F3BISH-HK13	1000FBC13*D16	1000	80.25	64	44.25	7600	K	F

0° Phase Shift - Aluminum — 3 Phase

Aluminum Primary: 480D Secondary: 208Y/120ZZ Shielded 0° Phase Shift								
Catalog Number	Alt #	kVA	Width (Inches)	Depth (Inches)	Height (Inches)	Weight (Lbs)	Wiring Diagram	Dimension Drawing
HT15A3B2SHZZ-D16	15YSSHZZ*D16	15	28	21	14	245	L	A
HT30A3B2SHZZ-D16	30YSSHZZ*D16	30	32	26.5	17	335	L	B
HT45A3B2SHZZ-D16	45YSSHZZ*D16	45	32	26.5	17	400	L	B
HT75A3B2SHZZ-D16	75YSSHZZ*D16	75	38.5	28.5	20	545	L	B+
HT112A3B2SHZZ-D16	112YSSHZZ*D16	112	40.5	31.5	27.75	755	L	C
HT150A3B2SHZZ-D16	150YSSHZZ*D16	150	40.5	36.5	21.75	900	L	C+
HT225A3B2SHZZ-D16	225YSSHZZ*D16	225	51.5	40.5	26.5	1585	L	D
HT300A3B2SHZZ-D16	300YSSHZZ*D16	300	51.5	40.5	26.5	2000	L	D
HT500A3B2SHZZ-D16	500YSSHZZ*D16	500	66	50.5	32	2800	L	E
HT750A3B2SHZZ-D16	750YSSHZZ*D16	750	80.25	64	44.25	3800	L	F
HT1000A3B2SHZZ-D16	1000YSSHZZ*D16	1000	80.25	64	44.25	5000	L	F

Aluminum Primary: 600D Secondary: 208Y/120ZZ Shielded 0° Phase Shift								
Catalog Number	Alt #	kVA	Width (Inches)	Depth (Inches)	Height (Inches)	Weight (Lbs)	Wiring Diagram	Dimension Drawing
HT15F3B2SHZZ-D16	15FBSHZZ*D16	15	28	21	14	245	L	A
HT30F3B2SHZZ-D16	30FBSHZZ*D16	30	32	26.5	17	335	L	B
HT45F3B2SHZZ-D16	45FBSHZZ*D16	45	32	26.5	17	400	L	B
HT75F3B2SHZZ-D16	75FBSHZZ*D16	75	38.5	28.5	20	545	L	B+
HT112F3B2SHZZ-D16	112FBSHZZ*D16	112	40.5	31.5	27.75	755	L	C
HT150F3B2SHZZ-D16	150FBSHZZ*D16	150	40.5	36.5	21.75	900	L	C+
HT225F3B2SHZZ-D16	225FBSHZZ*D16	225	51.5	40.5	26.5	1585	L	D
HT300F3B2SHZZ-D16	300FBSHZZ*D16	300	51.5	40.5	26.5	2000	L	D
HT500F3B2SHZZ-D16	500FBSHZZ*D16	500	66	50.5	32	2800	L	E
HT750F3B2SHZZ-D16	750FBSHZZ*D16	750	80.25	64	44.25	3800	L	F
HT1000F3B2SHZZ-D16	1000FBSHZZ*D16	1000	80.25	64	44.25	5000	L	F

-30° Phase Shift - Aluminum — 3 Phase

Aluminum Primary: 480Y/277 Secondary: 208Y/120ZZ Shielded -30° Phase Shift								
Catalog Number	Alt #	kVA	Width (Inches)	Depth (Inches)	Height (Inches)	Weight (Lbs)	Wiring Diagram	Dimension Drawing
HT15D3B2SHZZ-D16	15DBSHZZ*D16	15	28	21	14	245	M	A
HT30D3B2SHZZ-D16	30DBSHZZ*D16	30	32	26.5	17	335	M	B
HT45D3B2SHZZ-D16	45DBSHZZ*D16	45	32	26.5	17	400	M	B
HT75D3B2SHZZ-D16	75DBSHZZ*D16	75	38.5	28.5	20	545	M	B+
HT112D3B2SHZZ-D16	112DBSHZZ*D16	112	40.5	31.5	27.75	755	M	C
HT150D3B2SHZZ-D16	150DBSHZZ*D16	150	40.5	36.5	21.75	900	M	C+
HT225D3B2SHZZ-D16	225DBSHZZ*D16	225	51.5	40.5	26.5	1585	M	D
HT300D3B2SHZZ-D16	300DBSHZZ*D16	300	51.5	40.5	26.5	2000	M	D
HT500D3B2SHZZ-D16	500DBSHZZ*D16	500	66	50.5	32	2800	M	E
HT750D3B2SHZZ-D16	750DBSHZZ*D16	750	80.25	64	44.25	3800	M	F
HT1000D3B2SHZZ-D16	1000DBSHZZ*D16	1000	80.25	64	44.25	5000	M	F

-30° Phase Shift - Aluminum — 3 Phase

Aluminum | Primary: 600Y/346 | Secondary: 208Y/120ZZ | Shielded | -30° Phase Shift

Catalog Number	Alt #	kVA	Width (Inches)	Depth (Inches)	Height (Inches)	Weight (Lbs)	Wiring Diagram	Dimension Drawing
HT15S3B2SHZZ-D16	15SBSHZZ*D16	15	28	21	14	245	M	A
HT30S3B2SHZZ-D16	30SBSHZZ*D16	30	32	26.5	17	335	M	B
HT45S3B2SHZZ-D16	45SBSHZZ*D16	45	32	26.5	17	400	M	B
HT75S3B2SHZZ-D16	75SBSHZZ*D16	75	38.5	28.5	20	545	M	B+
HT112S3B2SHZZ-D16	112SBSHZZ*D16	112	40.5	31.5	27.75	755	M	C
HT150S3B2SHZZ-D16	150SBSHZZ*D16	150	40.5	36.5	21.75	900	M	C+
HT225S3B2SHZZ-D16	225SBSHZZ*D16	225	51.5	40.5	26.5	1585	M	D
HT300S3B2SHZZ-D16	300SBSHZZ*D16	300	51.5	40.5	26.5	2000	M	D
HT500S3B2SHZZ-D16	500SBSHZZ*D16	500	66	50.5	32	2800	M	E
HT750S3B2SHZZ-D16	750SBSHZZ*D16	750	80.25	64	44.25	3800	M	F
HT1000S3B2SHZZ-D16	1000SBSHZZ*D16	1000	80.25	64	44.25	5000	M	F

0° Phase Shift - Copper — 3 Phase

Copper | Primary: 480D | Secondary: 208Y/120ZZ | Shielded | 0° Phase Shift

Catalog Number	Alt #	kVA	Width (Inches)	Depth (Inches)	Height (Inches)	Weight (Lbs)	Wiring Diagram	Dimension Drawing
HT15A3BISHZZ-D16	15YSSHZZC*D16	15	28	21	14	245	L	A
HT30A3BISHZZ-D16	30YSSHZZC*D16	30	32	26.5	17	335	L	B
HT45A3BISHZZ-D16	45YSSHZZC*D16	45	32	26.5	17	400	L	B
HT75A3BISHZZ-D16	75YSSHZZC*D16	75	38.5	28.5	20	545	L	B+
HT112A3BISHZZ-D16	112YSSHZZC*D16	112	40.5	31.5	27.75	755	L	C
HT150A3BISHZZ-D16	150YSSHZZC*D16	150	40.5	36.5	21.75	900	L	C+
HT225A3BISHZZ-D16	225YSSHZZC*D16	225	51.5	40.5	26.5	1585	L	D
HT300A3BISHZZ-D16	300YSSHZZC*D16	300	51.5	40.5	26.5	2000	L	D
HT500A3BISHZZ-D16	500YSSHZZC*D16	500	66	50.5	32	2800	L	E
HT750A3BISHZZ-D16	750YSSHZZC*D16	750	80.25	64	44.25	3800	L	F
HT1000A3BISHZZ-D16	1000YSSHZZC*D16	1000	80.25	64	44.25	5000	L	F

Copper | Primary: 600D | Secondary: 208Y/120ZZ | Shielded | 0° Phase Shift

Catalog Number	Alt #	kVA	Width (Inches)	Depth (Inches)	Height (Inches)	Weight (Lbs)	Wiring Diagram	Dimension Drawing
HT15F3BISHZZ-D16	15FBSHZZC*D16	15	28	21	14	245	L	A
HT30F3BISHZZ-D16	30FBSHZZC*D16	30	32	26.5	17	335	L	B
HT45F3BISHZZ-D16	45FBSHZZC*D16	45	32	26.5	17	400	L	B
HT75F3BISHZZ-D16	75FBSHZZC*D16	75	38.5	28.5	20	545	L	B+
HT112F3BISHZZ-D16	112FBSHZZC*D16	112	40.5	31.5	27.75	755	L	C
HT150F3BISHZZ-D16	150FBSHZZC*D16	150	40.5	36.5	21.75	900	L	C+
HT225F3BISHZZ-D16	225FBSHZZC*D16	225	51.5	40.5	26.5	1585	L	D
HT300F3BISHZZ-D16	300FBSHZZC*D16	300	51.5	40.5	26.5	2000	L	D
HT500F3BISHZZ-D16	500FBSHZZC*D16	500	66	50.5	32	2800	L	E
HT750F3BISHZZ-D16	750FBSHZZC*D16	750	80.25	64	44.25	3800	L	F
HT1000F3BISHZZ-D16	1000FBSHZZC*D16	1000	80.25	64	44.25	5000	L	F

-30° Phase Shift - Copper — 3 Phase

Copper | Primary: 480Y/277 | Secondary: 208Y/120ZZ | Shielded | -30° Phase Shift

Catalog Number	Alt #	kVA	Width (Inches)	Depth (Inches)	Height (Inches)	Weight (Lbs)	Wiring Diagram	Dimension Drawing
HT15D3BISHZZ-D16	15DBSHZZC*D16	15	28	21	14	245	N	A
HT30D3BISHZZ-D16	30DBSHZZC*D16	30	32	26.5	17	335	N	B
HT45D3BISHZZ-D16	45DBSHZZC*D16	45	32	26.5	17	400	N	B
HT75D3BISHZZ-D16	75DBSHZZC*D16	75	38.5	28.5	20	545	N	B+
HT112D3BISHZZ-D16	112DBSHZZC*D16	112	40.5	31.5	27.75	755	N	C
HT150D3BISHZZ-D16	150DBSHZZC*D16	150	40.5	36.5	21.75	900	N	C+
HT225D3BISHZZ-D16	225DBSHZZC*D16	225	51.5	40.5	26.5	1585	N	D
HT300D3BISHZZ-D16	300DBSHZZC*D16	300	51.5	40.5	26.5	2000	N	D
HT500D3BISHZZ-D16	500DBSHZZC*D16	500	66	50.5	32	2800	N	E
HT750D3BISHZZ-D16	750DBSHZZC*D16	750	80.25	64	44.25	3800	N	F
HT1000D3BISHZZ-D16	1000DBSHZZC*D16	1000	80.25	64	44.25	5000	N	F

Copper | Primary: 600Y/346 | Secondary: 208Y/120ZZ | Shielded | -30° Phase Shift

Catalog Number	Alt #	kVA	Width (Inches)	Depth (Inches)	Height (Inches)	Weight (Lbs)	Wiring Diagram	Dimension Drawing
HT15S3BISHZZ-D16	15SBSHZZC*D16	15	28	21	14	245	N	A
HT30S3BISHZZ-D16	30SBSHZZC*D16	30	32	26.5	17	335	N	B
HT45S3BISHZZ-D16	45SBSHZZC*D16	45	32	26.5	17	400	N	B
HT75S3BISHZZ-D16	75SBSHZZC*D16	75	38.5	28.5	20	545	N	B+
HT112S3BISHZZ-D16	112SBSHZZC*D16	112	40.5	31.5	27.75	755	N	C
HT150S3BISHZZ-D16	150SBSHZZC*D16	150	40.5	36.5	21.75	900	N	C+
HT225S3BISHZZ-D16	225SBSHZZC*D16	225	51.5	40.5	26.5	1585	N	D
HT300S3BISHZZ-D16	300SBSHZZC*D16	300	51.5	40.5	26.5	2000	N	D
HT500S3BISHZZ-D16	500SBSHZZC*D16	500	66	50.5	32	2800	N	E
HT750S3BISHZZ-D16	750SBSHZZC*D16	750	80.25	64	44.25	3800	N	F
HT1000S3BISHZZ-D16	1000SBSHZZC*D16	1000	80.25	64	44.25	5000	N	F

Notes



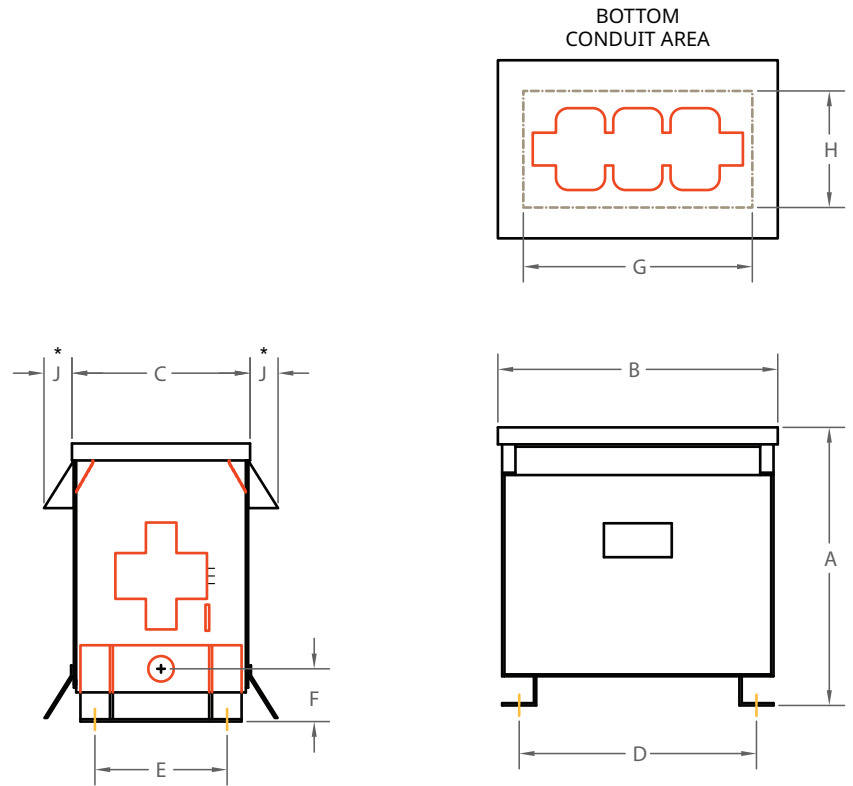

AVAILABLE ACCESSORIES	
Bottom Mount Wall Bracket	
Side Mount Wall Bracket	
OSHPD Seismic Kits	
Rain Hoods/Weather Shield Kits	
Rodent/Bird Screen	

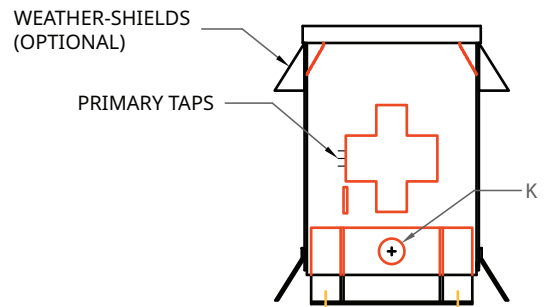

kVA	DIMENSIONS (Inches)										Wall Bracket	Weather Shield	Enclosure
	A	B	C	D	E	F	G	H	J	K			
9- 15	28	21	14	18 ^{1/2}	11 ^{1/2}	-	16	7	-	-	WBI/NWB	†	GPA
25-50	32	26 ^{1/2}	17	23	14	-	21 ^{1/2}	10	-	-	WBI/NWB	†	GPB
75	38 ^{1/2}	28 ^{1/2}	20	26	17 ^{1/2}	-	23 ^{1/2}	13 ^{1/2}	-	-	WB2/NWB	†	GPB+
112.5	40 ^{1/2}	31 ^{1/2}	21 ^{3/4}	28 ^{1/2}	19	-	26 ^{1/2}	14 ^{3/4}	-	-	WB3	†	GPC
150	40 ^{1/2}	36 ^{1/2}	21 ^{3/4}	33 ^{1/2}	19	-	31 ^{1/2}	14 ^{3/4}	-	-	WB3	†	GPC+
225- 300	51 ^{1/2}	40 ^{1/2}	26 ^{1/2}	37	21	10 ^{1/2}	34	19	4 ^{5/8}	5"	-	RH5*	GPD
500	66	50 ^{1/2}	32	47 ^{1/2}	24	11 ^{1/2}	44	24	4 ^{5/8}	2-5"	-	RH6*	GPE

*GPD and GPE enclosures require weather shield kits for outdoor (NEMA 3R) installations.
 † "†" Dual rated enclosures suitable for indoor or outdoor installations. (NEMA I, NEMA 3R)

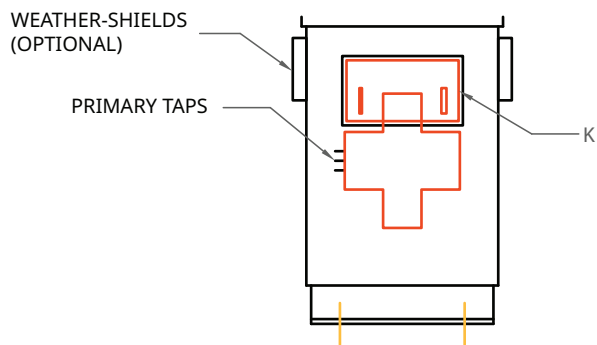
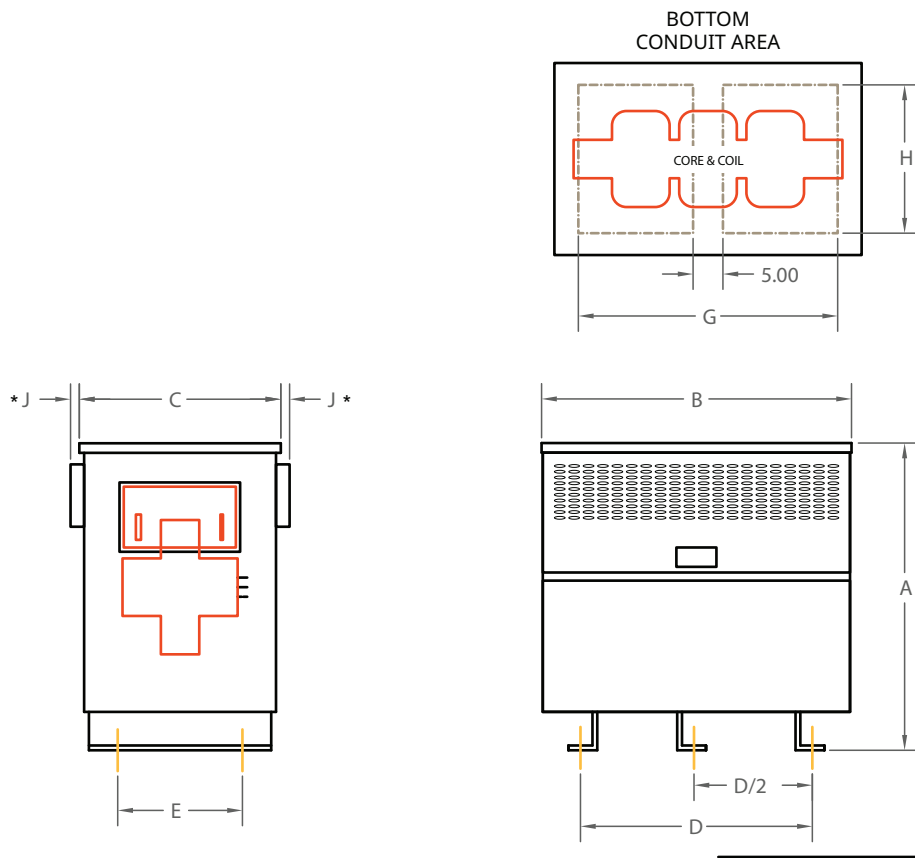

kVA	DIMENSIONS (Inches)										Weather Shield	Enclosure
	A	B	C	D	E	F	G	H	J	K		
750 - 1,000	80 ^{1/4}	64	44 ^{1/4}	51 ^{1/2}	40	-	45.50	38.25	3	26" x 30"	Louver*	GPF



MGM Transformers,
5701 Smithway St.
Commerce, CA 90040

(323) 726-0888

Fax: (323) 726-8224

mgmtransformers.com

sales@mgmtransformers.com

MGMT- Bulletin 10- 012025